

RADIO CRAFT

▼ AND POPULAR ELECTRONICS ▼



2 - MILE
SURRENDER SPEAKER
SEE PAGE 80

ALEX
SCHOMBURG

NOVEMBER

1944

25¢

CANADA 30¢

RADIO-ELECTRONICS IN ALL ITS PHASES

BOGEN

SOUND

EQUIPMENT...

SERVING

ON ALL FRONTS

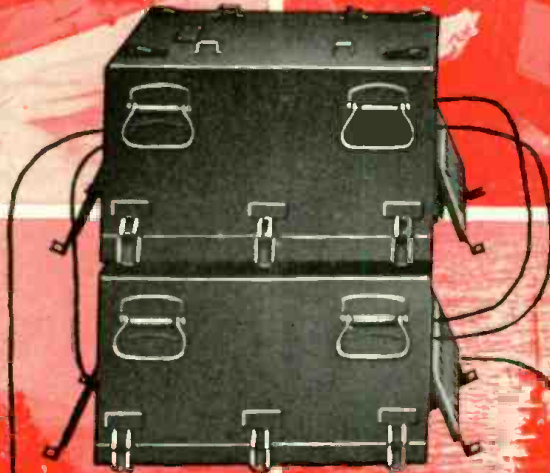

OFFICIAL U. S. NAVY,
MARINE CORPS PHOTOS.

Ultra High-Powered Sound...another BOGEN first for post-war markets!

Campaign ribbons are truly citations for military apparatus. For equipment—to serve in varying climates, temperatures and types of warfare—must be functionally efficient, dependable and long-lasting.

The BOGEN MC-225, identified by the Army as type AN UIQ-1, and by the Navy, Marine Corps and Amphibious Command as the Portable Beachmaster Announcing Equipment, is illustrated above. This system has seen extensive action in Normandy, as well as in the Battle of France in its entirety. Numerous other phases of its service include amphibious

landings in the South Pacific, and more recently, a vital contribution to the success of the airborne invasion of Holland.

BOGEN sound engineers—by developing, designing and building ultra high-powered sound systems for every branch of the Armed Forces—have gained the knowledge essential to leadership in the field. The experience gained "under fire" will lend impetus to both theory and actuality

for tomorrow's applications.

BOGEN Sound Systems—setting a new standard for Industrial Program Equipment—for announcing, intercommunication and public address broadcasting—will be available for schools, hospitals, churches, industrial plants, airports, railway systems, recreation centers, etc.

BOGEN engineers are ready to assist you in the planning of sound equipment needs. Inquiries are invited.

David Bogen CO. INC.



BOGEN SOUND SYSTEMS • AMPLIFIERS
COMMUNO-PHONES • ELECTRONIC EQUIPMENT

663 BROADWAY, NEW YORK, 12, N. Y.

I WILL TRAIN YOU TO START A SPARE TIME OR FULL TIME RADIO SERVICE BUSINESS WITHOUT CAPITAL

J. E. SMITH,
PRESIDENT
National Radio
Institute
30th Year of
Training Men
for Success
in Radio

You Build These and Many Other Radio Circuits with 6 Kits of Parts I Supply

By the time you've conducted 60 sets of Experiments with Radio Parts I supply, made hundreds of measurements and adjustments, you'll have valuable PRACTICAL Radio experience for a good full or part-time Radio job!

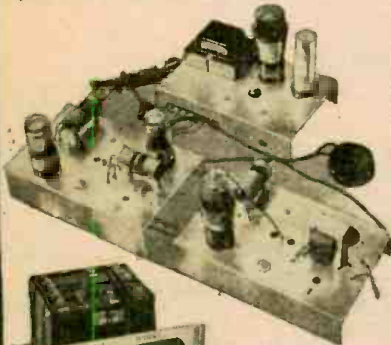

You build MEASURING INSTRUMENT above early in Course, useful for Radio work to pick up EXTRA spare time money. It is a vacuum tube multimeter, measures A.C., D.C., R.F. volts, D.C. currents, resistance, receiver output.

Building the A. M. SIGNAL GENERATOR at right will give you valuable experience. Provides amplitude-modulated signals for test and experimental purposes.

You build the SUPERHETERODYNE CIRCUIT above containing a preselector oscillator-mixer-first detector, i.f. stage, diode-detector-a.v.c. stage and audio stage. It will bring in local and distant stations. Get the thrill of learning at home evenings in spare time while you put the set through fascinating tests!



The men at the right are just a few of many I have trained, at home in their spare time, to be Radio Technicians. They are now operating their own successful spare time or full time Radio businesses. Hundreds of other men I trained are holding good jobs in practically every branch of Radio, as Radio Technicians or Operators. Doesn't this PROVE that my "50-50 Method" of training can give you, in your spare time at home, BOTH a thorough knowledge of Radio principles and the PRACTICAL experience you need to help you make more money in the fast-growing Radio industry?

Right now you have excellent opportunities to get a good job in this busy field with a bright peacetime future! So mail the Coupon and I'll send you FREE my 64-page, illustrated book, "Win Rich Rewards in Radio." It describes many fascinating types of Radio jobs, tells how N.R.I. trains you at home in spare time—how you get practical experience building and testing Radio Circuits with SIX BIG KITS OF RADIO PARTS I send!

Big Demand Now for Well Trained Technicians, Operators

Keeping old Radios working is booming the Radio Repair business. Profits are large, after-the-war prospects are bright, too. Think of the new boom in Radio Sales and Servicing that's coming when new Radios are again available—when Frequency Modulation and Electronics can be promoted—when Television starts its postwar expansion!

Broadcasting Stations, Aviation Radio, Police Radio, Loudspeaker Systems, Radio Manufacturing all offer good jobs now to qualified Radio men—and most of these fields have a big backlog of business that has built up during the war, plus opportunities to expand into new fields opened by wartime developments. You may never see a time again when it will be so easy to get a start in Radio!

Many Beginners! Soon Make \$5, \$10 a Week EXTRA in Spare Time

The day you enroll for my Course I start sending you EXTRA MONEY JOB SHEETS that help show how to make EXTRA money fixing Radios in spare time while still learning. I send you SIX big kits of Radio parts as part of my Course. You LEARN Radio fundamentals from my Illustrated, easy-to-grasp lessons—PRACTICE what you learn by building real Radio Circuits—PROVE what you learn by interesting tests on the circuits you build!

Find Out What N.R.I. Can Do For YOU

MAIL THE COUPON for Sample Lesson and my 64-page book FREE. My book, "Win Rich Rewards in Radio," is packed with facts, things you never knew about opportunities in Broadcasting, Radio Servicing, Aviation Radio, other Radio fields. Read the details about my Course—"50-50 Training Method"—8 Experimental Kits—EXTRA MONEY JOB SHEETS. See the fascinating jobs Radio offers and how you can train at home. Read many letters from men I trained telling what they are doing, earning. No obligation. Just MAIL COUPON in an envelope or pasted on a penny postcard!—J. E. SMITH, President, Dept. 4MX, National Radio Institute, Washington 9, D. C.

I Trained These Men

SPARE TIME RADIO BUSINESS



"I really don't see how you can give so much for such a small amount of money. I made \$600 in a year and a half, and just spare time."—JOHN JERRY, 300 So. H. St., Exeter, Calif.



"I am engaged in spare time Radio work. I average from \$5 to \$10 a week. I often wished that I had enrolled sooner, because all this EXTRA money sure does come in handy."—THEODORE N. DUBREE, Hershman, Pa.



"I am still attending school and do spare time work in my radio shop at home. I earned about \$427 in spare time while taking your course."—DIETER HESS, 72 Worth Avenue, Hudson, N. Y.

I Trained These Men

FULL TIME RADIO BUSINESS



"For several years I have been in business for myself making around \$200 a month. Business has steadily increased. I have N.R.I. to thank for my start in this field."—ARLIE J. FROEHNER, 300 W. Texas Ave., Goose Creek, Texas.

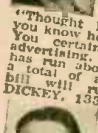

"Thought I would drop a line to let you know how well I have done in Radio. You certainly tell the truth in your advertising. For this year in your bill total of about \$3,000. I have taken in \$11,000. I have taken in \$1,700."—BERYL DICKERY, 1331 P. Ave., New Castle, Ind.



"I am now operating a radio shop for myself and own all my equipment. For over a year I have only repaired radios \$200 a month and in 1942 I averaged \$250 a month."—M. SCRIVENER, JR., Aberdeen, Miss.

SAMPLE LESSON FREE

I will send you a FREE Lesson, "Getting Acquainted With Receiver Servicing," to show you how practical it is to train for Radio at home in spare time. It's a valuable lesson. Study it—keep it—use it—without obligation! Tells how Superheterodyne Circuits work, gives hints on Receiver Servicing, Locating Defects, Repair of Loudspeaker, I.F. Transformer, Gang Tuning Condenser, etc. 31 Illustrations.



My Radio Course Includes
TELEVISION • ELECTRONICS
FREQUENCY MODULATION

GOOD FOR BOTH 64 PAGE BOOK FREE

J. E. SMITH, President, Dept. 4MX
National Radio Institute, Washington 9, D. C.

Without obligating me, mail your Sample Lesson and 64-page book, FREE. I am particularly interested in the branch of Radio checked below. (No salesman will call. Please write plainly.)

- | | |
|--|--|
| <input type="checkbox"/> Radio Service Business of My Own | <input type="checkbox"/> Aviation Radio |
| <input type="checkbox"/> Service Technician for Radio Stores and Factories | <input type="checkbox"/> Operating Broadcasting Stations |
| <input type="checkbox"/> Spare Time Radio Servicing | <input type="checkbox"/> Army, Navy Radio Jobs |
| <input type="checkbox"/> Government Civilian Radio | <input type="checkbox"/> Operating Police Radio Stations |
| | <input type="checkbox"/> Operating Ship and Harbor Radio |

(If you have not decided which branch you prefer—mail coupon for facts to help you decide.)

NAME AGE.....
ADDRESS
CITY STATE..... 4FR



RADIO CRAFT

AND POPULAR ELECTRONICS

MEMBER
AUDIT BUREAU OF CIRCULATIONS

HUGO GERNSBACK, *Editor-in-Chief*
 FRED SHUNAMAN, *Associate Editor*
 I. QUEEN, *Editorial Associate*
 ELMER FULLER, *Shortwave Editor*
 A. PASCALE, *Production Manager*
 G. ALIQUO, *Circulation Manager*
 JOHN J. LAMSON, *Advertising Director*
 ALFRED STERN, *Promotion Manager*

IN THE NEXT ISSUE

WERS Transmitter-Receivers
 Problems of Railroad Radio
 Marines and Radio Service
 Principles of Square Waves

Published by Radcraft Publications, Inc.
 Publication Office: 29 Worthington
 Street, Springfield 3, Mass.

Editorial and Advertising Offices: 25
 West Broadway, Tel. RE2-9690, New
 York 7, N. Y.

Chicago Advertising Office: Radio-Craft,
 520 North Michigan Avenue, Tel. Su-
 perior 7306, Chicago 11, Ill.

Cleveland Advertising Office: 405 Erie
 Bldg., Cleveland, Ohio. Burdette Phil-
 lips, Manager. Tel. Main 9645.

Los Angeles Office: Robt. H. Deibler &
 Associates, 403 W. Eighth St., Tucker
 1579.

RADIO-CRAFT is published monthly,
 on the 25th of the month preceding that
 of date; subscription price is \$2.50 per
 year in U. S. (In foreign countries, 75c
 additional per year to cover postage;
 Canada, 50c additional.) Special rates
 for members of the Armed forces in
 U. S., or those addressed by A.P.O. or
 F.P.O. mail, \$2.00. Entered at the post
 office at Springfield as second-class mat-
 ter under the Act of March 3, 1879. All
 communications about subscriptions
 should be addressed to: Circulation
 Manager, Radio-Craft, 29 Worthington
 St., Springfield 3, Mass.

Notice of CHANGE of ADDRESS should
 reach us at least one month in advance. When
 ordering a change, please furnish an address
 stencil impression from a recent wrapper if
 you can. Address changes cannot be made
 without the old address as well as the new.

Foreign Agents

London—Atlas Publishing and Distributing
 Co., Ltd., 18 Bride Lane, Fleet St., London,
 E.C. 4.

Melbourne—McGill's Agency, 179 Elizabeth
 St., Australia.

Text and illustrations of this magazine are
 copyright and must not be reproduced without
 permission of the copyright owners.
 Copyright, 1944, Radcraft Publications, Inc.

Contents November, 1944 Volume XVI, No. 2

Editorial: Coming "Secret" Weapons.....	by Hugo Gernsback	75
Radio-Electronics Monthly Review.....		76
Sally, the Service Maid—Case of the Crystal Pickup.....	by Nate Silverman	96

ELECTRONICS

The Magnetic Motor.....	by the Editors	78
Electronics and Air Power, Part III.....	by Ted Powell	81
Electronics and Printing.....	by Phil Glanzer	82
Industrial Electronics, Part IX.....	by Raymond F. Yates	84
Oscilloscopes in Industry, Part II.....	by Werner Muller	87

WARTIME RADIO

Surrender Speaker (Cover Feature).....	by Hugo Gernsback	80
--	-------------------	----

RADIO TRAINING

The Tracking Problem.....	by Eric Leslie	85
Broadcast Equipment, Part III.....	by Don C. Hoefler	91

SOUND

Speech Amplifiers, Part II.....	by Robert F. Scott	88
Silent Recording Methods.....	by I. Queen	89
Economy 20-Wattter.....	by John W. Straede	92

SERVICING

Record Changers.....	by John Needre	93
----------------------	----------------	----

TEST INSTRUMENTS

Dynamic Tube Tester.....	by John A. Dewar	94
--------------------------	------------------	----

DEPARTMENTS

New Radio-Electronic Devices.....		98
The Question Box.....		100
Radio-Electronic Circuits.....		102
Try This One!.....		104
World-Wide Station List.....	Edited by Elmer R. Fuller	106
Progress in Invention.....	Conducted by I. Queen	112
Technotes.....		115
The Mail Bag.....		124
Book Reviews.....		127

ON THE COVER

Our cover this month shows one of the U. S. Army's
 surrender speakers, or "Schweinheilgers," as they
 are called by G.I. Joe. The special multiple-unit
 horn is mounted on a tripod and excited by an am-
 plifier which can supply 350 watts. Under good con-
 ditions, the words are understandable at two miles.





The United States Navy has awarded the men and women of Hallcrafters a special "Certificate of Achievement"... first award of its kind... for outstanding service with the radar-radio industries of Chicago in speeding vital war material to the Navy. Added to the four Army-Navy "E" awards, this makes five times Hallcrafters workers have been cited for distinguished service. They promise that this kind of service will be continued until total victory is ours.

★ BUY A WAR BOND TODAY

hallicrafters RADIO



THE HALLCRAFTERS CO., MANUFACTURERS OF RADIO AND ELECTRONIC EQUIPMENT, CHICAGO 16, U. S. A.

THE SET THAT

never slept

10,800 Continuous Hours

Fifteen months of continual service, 10,800 continuous hours, night and day with the switch never once turned off—and no repairs or replacements needed. That's the record established by a Hallicrafters SX-28 in use testing crystal standards at Scientific Radio Products Co., Council Bluffs, Iowa.

Equal to Five Years' Use

Witness to this amazing performance was Myron C. Jones, resident inspector in charge. Day after day he watched "the set that never slept" in continuous action between January 5, 1943 and April 10, 1944.

Inspector Jones writes:

"This is what I call punishment. It surpasses five years of ordinary use, with no new parts needed. This war plant had many more Hallicrafters receivers, all performing outstandingly. You can't beat Hallicrafters for endurance, sensitivity, selectivity, tone, ease of operation and all around performance."

"The Radio Man's Radio"

This is only one more significant notch in Hallicrafters' record. Men who know radios inside out, men who depend on them when life itself is at stake and when there can be no compromise with quality, specify Hallicrafters, "the radio man's radio."



BUY A WAR BOND TODAY!



hallicrafters RADIO

THE HALLICRAFTERS CO., MANUFACTURERS OF RADIO AND ELECTRONIC EQUIPMENT, CHICAGO 16, U. S. A.

SPRAYBERRY RADIO TRAINING

Gives you Both



FULL RADIO SET SUPPLIED FOR SHOP PRACTICE!

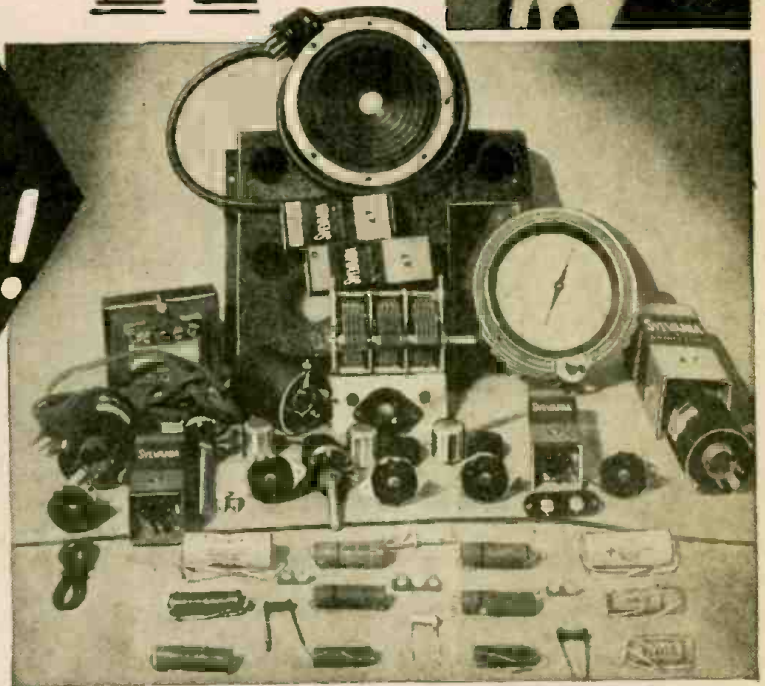

HERE'S THE ONE PRACTICAL WAY TO TRAIN FOR BIG EARNINGS AHEAD IN RADIO-ELECTRONICS & TELEVISION

The offer I make you here is the opportunity of a lifetime. It's your big chance to get ready for a wonderful future in the swiftly expanding field of Radio-Electronics INCLUDING Radio, Television, Frequency Modulation and Industrial Electronics. Be wise! NOW'S the time to start. No previous experience is necessary. The Sprayberry Course starts right at the beginning of Radio. You can't get lost. It gets the various subjects across in such a clear, simple way that you understand and remember.

I'll Show You a New, Fast Way to Test Radio Sets Without Manufactured Equipment

The very same Radio Parts I supply with your course for gaining pre-experience in Radio Repair work may be adapted through an exclusive Sprayberry wiring procedure to serve for complete, fast, accurate Radio Receiver trouble-shooting. Thus under Sprayberry methods you do not have one cent of outlay for manufactured Test Equipment which is not only expensive but scarce.

Prepares You For a Business of Your Own or Good Radio Jobs . . . Civilian or Military

My training will give you the broad, fundamental principles so necessary as a background no matter which branch of Radio you wish to specialize in. I make it easy for you to learn Radio Set Repair and Installation Work. I teach you how to install and repair Electronic Equipment. If you enter the Army, Navy or Marines, my training will help you win higher ratings and better pay.

JUST OUT! FREE! HOW TO READ RADIO DIAGRAMS AND SYMBOLS

... a valuable new book which explains in simple, non-technical English how to read and understand any Radio Set Diagram. Provides the quick key to analyzing any Radio circuit. Includes translations of all Radio symbols. Send for this FREE book now while supply lasts and along with it I will send you another big FREE book describing my Radio-Electronic training.



GET FREE BOOKS

SPRAYBERRY ACADEMY OF RADIO
F. L. Sprayberry, Pres.
Box 500TL
Pueblo, Colorado

Please rush my FREE copies of "HOW TO MAKE MONEY IN RADIO, ELECTRONICS and TELEVISION," and "HOW TO READ RADIO DIAGRAMS and SYMBOLS."

Name Age

Address

City State

Tear off this coupon, mail in envelope or paste on penny postcard.

WHY PERSONNEL BECAME PRECISION-EL



As the fame of Meissner personnel began to spread, a new descriptive word came into being, rapidly caught hold. Precisely describing the ultimate in ability to do precision work, it is, naturally enough, "precision-el!"

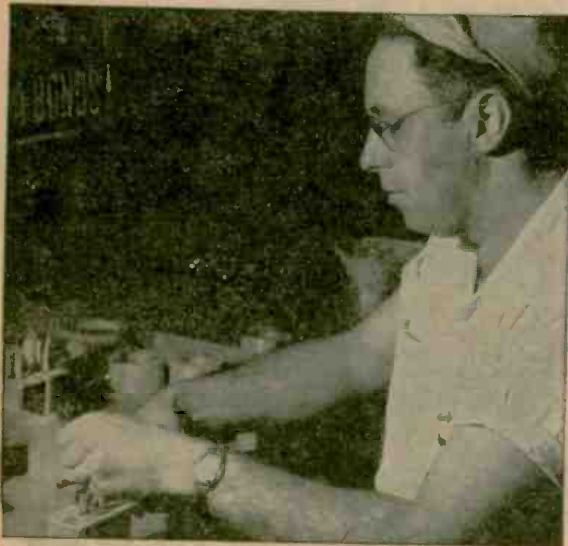

A thousand miles from New York—200 or more from Chicago—is a little city where hundreds devote their working lives to electronics. They have developed exceptional facility, resourcefulness, and pride of workmanship. The city is Mt. Carmel, Illinois, and Meissner is its leading industry.



Pictured on this page are four of the many craftsmen who make Meissner synonymous with quality in the manufacture of a wide range of precision-built radio products. Conscientious, capable... they are your guarantee of lasting satisfaction.



Easy Way To "Step Up" Old Receivers!

Designed primarily as original parts in high-gain receivers, these Meissner Ferrocart I. F. Input and Output Transformers get top results in stepping up performance of today's well-worn receivers. Their special powdered iron core permits higher "Q" with resultant increase in selectivity and gain. All units double-tuned, with ceramic base, mica dielectric trimmers, thoroughly impregnated Litz wire, and shield with black crackle finish. Frequency range, 360-600. List price, \$2.20 each.

MEISSNER

MANUFACTURING COMPANY • MT. CARMEL, ILL.

ADVANCED ELECTRONIC RESEARCH AND MANUFACTURE

Export Division: 25 Warren St., New York; Cable: Simontrice

RADIO-CRAFT for NOVEMBER, 1944

Now You can Use.



ALL OF THESE RADIO PARTS to help You learn RADIO

YOU CAN BUILD **133** FASCINATING EXPERIMENTS

FASTER-EASIER AT HOME

At home—in your spare time—you get real Radio experience with these many Radio parts and sub-assemblies. DeForest's practical equipment system (as pictured above) saves time . . . speeds experiments. You quickly build Radio Receiving Circuits that work . . . a Light Beam Transmitter, Electric Eye Devices, a Radio Telephone, and scores of other fascinating projects. Learning Radio at home is practical, effective, and fun—with DeForest's interesting "Home Laboratory."

YOU USE "LEARN-BY-SEEING" MOVIES!

Think of the pleasure, as well as help you get from the use of this DeVRY Motion Picture Projector and exciting "movie" TRAINING FILMS. You will be surprised how much faster . . . easier . . . Home Movies help you understand Radio-Electronic fundamentals. Here's a preferred training method of tomorrow—yours today. SEE the principles of what you're learning—in motion . . . ANIMATED! See circuit actions otherwise hidden from the eye. You get this big Radio home training advantage—exclusively with DeFOREST'S. So act now!



DeFOREST'S TRAINING, INC. CHICAGO 14, ILLINOIS

VETERANS!

The Billion Dollar Radio-Electronic Industry, with its Manufacturing, Servicing, Broadcasting, Communications, and many other promising fields, invites your careful consideration. See how DeFOREST'S helps you prepare for a good pay job, or a business of your own in one of America's most promising post-war fields.

YOU GET "ALL THREE" WITH DeFOREST'S

Where else can you get such a combination of *proved major training features* as—(1) 90 modern, loose-leaf lessons prepared under the supervision of Dr. Lee DeForest, often called the "Father of Radio," (2) the use of "Learn-by-Seeing" home training films and a genuine 16-mm. DeVRY movie projector, and (3) the use of Electronic assemblies and parts to build 133 practical experiments.

Write for DeForest's big, free book, "VICTORY FOR YOU" that has helped many to good pay jobs in essential industries—others to preferred military classifications—still others to interesting, profitable businesses of their own. See how you can prepare for a bright future now—in your spare time at home—and then get started toward a Radio-Electronics job with the help of DeForest's effective EM-

PLOYMENT SERVICE. Coupon below brings you illustrated "VICTORY FOR YOU" book—also colorful Kit Supplement. *You be the judge.* No obligation. Mail the coupon today.

DeFOREST'S TRAINING INCLUDES
INSTRUCTION IN MOTION PICTURE
SOUND EQUIPMENT, FM RADIO
AND TELEVISION



DeFOREST'S TRAINING, INC., Dept. RC-8
2535-41 N. Ashland Ave., Chicago 14, Illinois, U. S. A.

Send—FREE and WITHOUT OBLIGATION—illustrated book, "VICTORY FOR YOU" and KIT SUPPLEMENT, showing how Home Movies and Home Laboratory can speed my preparation for a place in the Radio-Electronics industry.

Name _____

Age _____

Address _____

City _____

State _____

- If under 16, check here for special information.
 If a veteran of World War II, check here.

Life Testing ON THE GRAND SCALE!

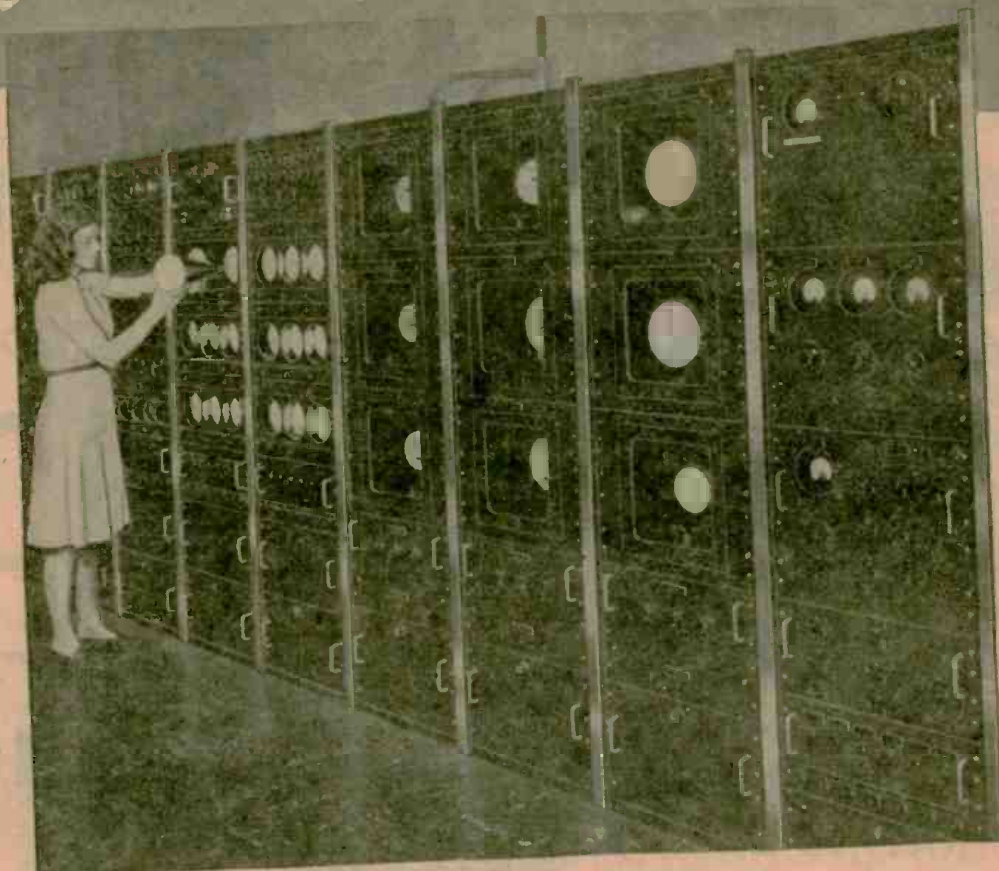

One of the most elaborate cathode-ray tube test racks in this country operates day and night, seven days a week at National Union. For, at N. U., cathode ray tube production is now reaching heights undreamed of in pre-war days. To achieve this production, entirely new testing techniques, on an unprecedented scale, have been developed.

Examples of the newest tried and proven products of National Union manufacture are the four cathode-ray tubes illustrated. All of these N. U. cathode ray types can be produced in a

variety of screen materials, which will have various post-war applications in television and industrial electronics.

Here at National Union are many such ultra-modern products ready for the greater post-war service and replacement needs of your customers. N. U. Tubes for television, FM, AM, receivers, transmitters, and many new household conveniences. Ready from the day our present obligations are fulfilled and reconversion can get under way. Count on National Union.

NATIONAL UNION RADIO CORPORATION, NEWARK, N. J.
Factories: Newark and Maplewood, N. J.; Lansdale and Robesonia, Pa.

NATIONAL UNION



RADIO AND ELECTRONIC TUBES

Transmitting, Cathode Ray, Receiving, Special Purpose Tubes • Condensers • Volume Controls • Photo Electric Cells • Panel Lamps • Flashlight Bulbs

MAKE MORE MONEY

RADIO TELEVISION & ELECTRONICS

Now!

GET THESE 3 BOOKS

FREE!

You men already in radio know how great the demand is for trained, experienced service men, operators and technicians. You know how fast the field is growing and how important it is to keep up with developments—FM receivers, television, electronics.

Or even if you are merely INTERESTED in radio as an amateur, you must recognize the WONDERFUL OPPORTUNITY right within your grasp to cash in on your natural talent. Make it pay dividends. Get into the EXPERT RADIO SERVICE Line. Be a TELEVISION specialist—OWN A BUSINESS OF YOUR OWN. Fill out and mail the coupon below for all the details.

Get the Latest Inside Information—
Trade Secrets by

SHOP-METHOD HOME TRAINING



Learn by Doing

Use Actual Radio Equipment Furnished With Your Course

Experience is the best teacher. You learn by experience with the exclusive National Shop-Method of Home Training—actually build many circuits and do experiments with the big kits of standard radio parts included in your training equipment at no extra cost to you.

In the course of your study you actually build various types of receivers—a powerful superheterodyne, a signal generator, an audio oscillator and others. You make tests and conduct experiments that show you the why and how of various elements of electronics operate because you actually see them work for you. Not only do you gain marvelous actual experience by this method of learning but you have valuable equipment you will use on the job in the practice of your profession as an electronics expert. Mail the coupon and learn what this means to you.



Now the famous National Schools brings its exclusive Shop-Method of training right in your own home. You can learn the most up-to-date, approved projects, systems and look-ups step by step in your spare time. This is the sound, practical training you want and need—the development of experienced instructors working with thousands of students right in the shops and experimental laboratories of National Schools—one of the most advanced trade educational centers of the world.

This is the MODERN SYSTEM OF TRAINING. It matches the rapid progress constantly being made in radio, television and electronics. It is TIME TESTED, too. National Schools has been training men for more than a third of a century. In essence this is the very same training that has helped thousands to more pay and greater opportunity. You owe it to yourself—your future—FREE to you when you send in the coupon.

National Trained Men Now Making the Best Money in History

The real value of National Training shows up in the quick progress our men make on the job. Joe Grumich of Lake Hiawatha, N. J., turned down a job most men would welcome. He writes: "My latest offer was \$5,800.00 as radio photo engineer, but I am doing well where I am now engaged. I am deeply indebted to National."

Ely Berkman, now on Station WOR, told us: "My salary has been boosted considerably and at the present time I am making over \$3,000.00 per year. Thanks to National Training." And from the far-off Hawaiian Islands, Wallace Choi sends this: "I am averaging \$325.00 a

month. I will say that I honestly owe all this to the excellent training I had at National." National is proud of the progress graduates are making all over the world. Read about their records yourself in the books we send you FREE.

Make Extra Money Right from the Start

You get ahead fast with National Training. Many beginners make good money on the side fixing radios and doing service work. You can turn your knowledge into cash after the first few lessons. Progress is rapid. You can actually SEE YOURSELF GET AHEAD, because the National Shop Method is so sound and practical.

Now, right now, is the time to grasp the opportunity of today—a successful career for tomorrow. Get into the big money, rapid advancement, a position of importance. A BUSINESS OF YOUR OWN. Radio, television and the whole field of electronics invites you. The industry is crying for trained men everywhere. A rapidly expanding industry—probably the greatest in history—holds out the promise of a rich future—prosperous security.

Train While You Are in Service

Prepare, right now, while you are in uniform, for a glorious secure future in the field of radio and televi-

1. A complete catalog describing the industry and the extensive training facilities of National Schools.

2. You receive a sample lesson illustrating the modern "Shop Method" instruction technique.

3. The vast opportunity field of Electronics, "The Dawn of a New World," is revealed in this fully illustrated book recently published.



tion when the war is over. Make good use of your spare time by taking your National Training now. Men in our armed service, or about to enter, get better ratings and more pay almost right from the start if they are trained in radio, television and electronics. The government needs experienced men in nearly all branches of the service. Prepare for present advancement and a sound future. Learn how easy it is the National way. We are so enthusiastic because we have seen the marvelous results of National Shop Method Home Training. Send in your coupon today and see for yourself.

NATIONAL SCHOOLS

LOS ANGELES 37, CALIFORNIA EST. 1905

MAIL OPPORTUNITY COUPON FOR QUICK ACTION

National Schools, Dept. 11RCR
4000 South Figueroa Street, Los Angeles 37, California

(Mail in envelope or paste on penny post card)

Mail me FREE the three books mentioned in your ad including a sample lesson of your course. I understand no salesman will call on me.

NAME AGE

ADDRESS

CITY STATE

Include your zone number

FREE LESSON INCLUDED

Examine the exclusive National Shop Method of Home Training. See for yourself how sound and practical it is. Be convinced that you can learn radio—electronics, television—quickly and easily in your spare time. You can't tell until you try. This trial is ABSOLUTELY FREE. And you may keep all the valuable material we send you without any obligation of any sort. Fill out the coupon immediately while you are thinking about it and drop it in the mail at once.

Thousands of men in the Army, Navy and Coast Guard have trained at National under U. S. Government sponsorship. You are the man who must be satisfied. Mail the coupon here for the three books that tell you the complete story of the marvelous new system of training in radio, electronics and television. Learn the facts of this exclusive shop-method of home training. See for yourself! **DECIDE FOR YOURSELF!** No salesman from National Schools will call on you.

CHECK TRANSMITTER FREQUENCY IN LESS THAN A MINUTE



THE BROWNING FREQUENCY METER, used by police and other emergency radio facilities for the past five years, is still the best meter for such services — because it was specifically designed for them. The design, which permits determination of any five frequencies from 1.5 to 120 Mc., makes for simplicity of operation which requires less than one minute to check one frequency. All Browning development work aims at specific, rather than broad, uses. Thus, all Browning equipment is best for its particular job. Furthermore, Browning Laboratory facilities are available for study and solution of your own, specific electronic engineering problems.

Write for data.



BROWNING

**LABORATORIES, INCORPORATED
WINCHESTER, MASSACHUSETTS**



Coming "Secret" Weapons

... Many new and secret weapons are on the horizon. Fantastic and incredible today, they will be realized tomorrow ...

HUGO GERNSBACK

A DISPATCH from Sweden late last September brought the news that the Nazis are experimenting with another new and secret weapon—their much publicized V-2. The V-1, which turned out to be the robot bomb, was at first pooh-poohed and made sport of in allied countries; but, nevertheless, it proved to be a real weapon, even if it was not a military one. While it did not help the Germans win the war, or even have any effect upon it, the flying bomb, as launched from the European mainland against England (and particularly London), proved to be a weapon of greater magnitude than was at first believed possible. It destroyed some sixty thousand London buildings and killed thousands of persons. The Germans are understood to be experimenting with a larger type of flying bomb—this one to be radio controlled.

The V-2, however, according to the Swedish dispatches, is an entirely different weapon. Its purpose is to stop any gasoline-operated engine—whether in an automobile, tank or airplane—at a distance. The dispatch, according to the *New York Times*, states that so far the weapon's range is only about 8,000 feet.

This electronic type of weapon must be taken seriously, because sooner or later it will be realized. There is nothing particularly new in the thought of an electric or radio ray, or wave, with an action at a distance. It is the old death-ray in a new dress. Nor is it as impossible as it sounds. Nikola Tesla in 1892, in his Colorado experiments, was able to burn out armatures of electric motors and generators at a distance of over seven miles. This he did by means of his high frequency generator which was popularly known under the name of "Tesla's Lightning Factory." Indeed, Tesla succeeded in lighting electric lamps without any intervening wires at a distance of several miles. These are actual facts and well attested. The catch was that the amount of energy he used was prodigious. Several thousand horsepower was used to obtain a small effect at a distance.

Present day electrical and radio engineers also can burn out armatures in cars and airplanes and disrupt their ignition systems, if they have sufficient power at their disposal. But it is most likely that such a weapon will not be of much use after it has been tried out in

practice. As a surprise weapon it may stop some cars and tanks and maybe bring down a few airplanes, but it is also true that quick counter measures can be taken which will make this type of secret weapon useless.

This long-heralded weapon has been in the news for over a generation, and many scientists and experimenters have had a hand in it, but no efficient model has been evolved so far. That does not mean that sooner or later a real weapon of this type will not be produced.

We still know little of some electro-magnetic radiations: one of the latest, the cosmic ray, for instance, is still an unknown quantity, but it may hold some terrifying secrets for war purposes for the future. We are also getting closer to propagating powerful radio waves which may have destructive qualities and which can be directed over a very narrow beam, much as a searchlight can be beamed towards an airplane. It is conceivable that in the future such radio beams of great power could even be used to detonate the bombs carried by an airplane, blow up ammunition dumps, explode ammunition magazines of battleships, etc. But all this still lies in the future. It is not as yet right around the corner. Then, too, we have the old H. G. Wells' Martian heat ray. This also is no longer as fantastic as it sounded almost a generation ago. By electronic means, combined with some still unknown adjunct, it may well be possible to project a powerful heat ray over a distance where it may melt metals and burn human beings to a crisp.

Several thousand years ago Archimedes at Syracuse, Sicily, was supposed to have rigged up huge burning glasses which collected the sunlight and set afire the Roman galleys on which the rays were directed. But, simple as such a procedure is, we still do not know much about the propagation of light and heat. You have only to consider our sun 93 million miles distant from the earth. Once you get above the earth's atmosphere and into the vacuum of free space, there is no heat but intense cold, almost approaching the absolute zero. The vacuum is quite heatless and only where the sun's rays strike matter is there a heat effect.

In order to make use of the solar heat, you must have a solid or gaseous body (Continued on page 126)

Radio Thirty-Five Years Ago

In Gernsback Publications

HUGO GERNSBACK
Founder

Modern Electrics	1908
Electrical Experimenter	1913
Radio News	1919
Science & Invention	1920
Radio-Craft	1929
Short-Wave Craft	1930
Wireless Association of America	1908

Storing Wireless Energy.
Wireless Waves Made Visible.

Some of the larger libraries in the country still have copies of Modern Electronics on file for interested readers.

FROM the November, 1909, issue of MODERN ELECTRICS:

A New Condenser, by the Brussels Correspondent.

New Detector.

Ether of Space, by F. E. D'Humy.

A Variable Mica Condenser for Detectors, by H. W. Secor.

Wave Form Apparatus, by A. C. Marlowe.

Duplex Wireless.

Unusual Wireless Experience, by Ellery W. Stone.

A Transmitting Condenser, by Forrest P. Guptill.

Wireless As Burglar Alarm.

Arc for Radiophony.

High Speed Wireless.

"Powerless Wireless," by Jim Notus.

New Wireless Records.

Interesting Wireless Test.

Communication Chart.

An Improved Tuning Coil.

A Simple Detector, by Jacob Landau.

Lighting Lamp with Spark Coil.

Aerial Insulation.

THE FCC has just completed its own FM station. Built for a special purpose—that of obtaining technical data on FM operational characteristics—it operates from a motor trailer and has an output of 50 watts.

The new station, W3XFC, is authorized to operate on any frequency between 42,000 and 50,000 kilocycles with both wide- and narrow-band transmissions. Transmissions are confined to records, transcriptions and tone modulations.

It is expected that information gained from this station will be of value in handling the vexed question of frequency allocations.

MAPPING the path of a moving vehicle is now done automatically by means of a new partly electronic device, the *Odograph*, details of which were released by the United States Army last month.

To plot a course, it is necessary to know both the distance travelled and the direction of travel. In the *Odograph*, direction is determined by means of a magnetic compass properly corrected for the magnetic effects of the steel and iron of a vehicle. Distance is determined from the speedometer drive in the vehicle transmission. Distance and direction are combined mechanically in the plotting unit to give a corresponding movement of a plotting pencil on the map table. The electrical power source is the vehicle battery, and a power pack raises the battery voltage to the values needed in the electrical and electronic circuits. The *Odograph* can plot to any scale from 1 to 20,000 to 1 to 500,000.

The azimuth dial indicates the direction of the vehicle at any moment. Counters are provided which indicate the number of miles travelled east, west, north or south of a given starting point, and the total miles travelled. The map table is 8½ inches by 11 inches.

Uses of the *Odograph* may be roughly divided into two classifications: Map-making, or plotting the positions of objectives relative to a given base; and navigation, or finding objectives whose positions relative to a given base are known. These two uses often will be combined.



Brigadier-General J. W. N. Schulz, of the Engineers, discussing the jeep-mounted *Odograph*.

Radio-Electronics

Items Interesting

BRAZILLIAN radio stations feel the pinch of radio shortages so badly that no less than 43 may be forced to shut down for lack of transmitting tubes. This serious situation was revealed by Joao Amaral, president of the Sao Paulo Federation of Broadcasters, in an interview last month.

Mr. Amaral, who is in the United States in an attempt to obtain priorities for much-needed apparatus, said that already many stations are operating on shorter hours and with greatly reduced power.

Brazil is one of the most advanced of the Latin American countries in the use of radio. Current estimates credit the country with ownership of almost half South America's radio receivers, the figure being approximately 1,200,000.

STERILIZATION of vaccines, serums and other medicinal materials is now being done by short waves under circumstances which would render heat sterilization difficult or impossible, according to a last month's report in *Science News Letter*.

These materials are now often supplied in ampoules of plastic instead of glass. The customary heat treatment would soften and ruin some of these plastics. The problem was met by Rex E. Moule of Dayton, Ohio, by placing the ampoules between terminals sending intense beams of ultra-short waves through them. This effectively sterilizes the contents without affecting the plastic walls of the ampoules.

RADIOTELEGRAPH communication between New York and Paris, suspended since June, 1940, was re-established September 16, according to an RCA report last month.

The circuit is at present open to Government and press traffic only. Commercial messages may be handled at a later date.

The Paris circuit is one of the United States' oldest radio communication links with the European continent, having been opened by RCA in December, 1920. After the Germans took over Paris, direct radiotelegraph service with France was maintained through Bordeaux and Roanne, near Vichy. This service was discontinued, however, in December, 1942, when the United States broke off relations with the Vichy government.

Paris is the second great European capital with which RCA has reestablished direct radio communication this summer. The circuit between New York and Rome was reopened on June 13.

DISTINGUISHED service by the American Standards Association was recognized last month in the presentation of the Army's Award to representatives of the 80 national groups which make up the ASA membership.

The presentation was made by General Stewart E. Riemel, who, telling of the part played by standards in this war of quantity and precision, said in part:

"In the victories now being won in Europe and Asia the mass production technique of American industry has had a vital share. In the development of our mass production methods, and especially in the speedy utilization of our tremendous peacetime industrial facilities for war work, the standards developed through the leadership and cooperation of the American Standards Association have contributed immeasurably.

"Where new emergency war standards were required, the machinery of the Association was at the service of the government to produce the required standards in record time. Since Pearl Harbor, the development of more than a hundred emergency war standards has been undertaken by the Association. Some eighty-six of these have been completed and are now in use.

"For the Army and Navy these war standards have been developed to solve specific procurement problems; to aid in the design of new equipment; to help protect workmen in their plants; to enable both services to use identical specifications and thus simplify inspection problems; and to help make spare parts interchangeable in the field."

Dr. Osborne, chairman of the ASA Standards Council, asked to comment on the technical work that won the award, stated that three-fourths of the Association's work during the past year has been directly connected with war work, and that of the 266 American Standards other than War Standards completed since Pearl Harbor, at least 134 are of interest to Army Ordnance.

Monthly Review

to the Technician

THE VOICE of America, in the form of three new short-wave stations more powerful than any others in their class, began regular schedules last month. They are located at Bethany, Ohio, 20 miles from Cincinnati, and operate under the call signals WLWL, WLWR and WIWS.

The programs are handled by the Office of War Information and the Coordinator of Inter-American Affairs in their New York studios and are sent over telephone lines to the Bethany transmitters. In this way the Crosley Corporation is relieved of all responsibility as to the contents of the programs. The maintenance of the transmitters, antennas, and other equipment is the responsibility of the Broadcasting Division of the Crosley Corporation through the authority of the Office of War Information and the Coordinator of Inter-American Affairs.

The new transmitters will operate on a power of 250,000 watts eventually. Power outputs of 200 kilowatts have already been reached. Credit for design and construction goes to Crosley's chief engineer, J. R.

Rockwell, called Tinkertoy by some of his associates from his ability to contrive from material at hand any unobtainable equipment, from precision measuring apparatus to guy-wire clamps.

Twenty-four rhombic antennas, each 165 feet in the air, are arranged in a circle over nearly a square mile of land. Eight hundred masts are required to hold this system aloft, and with it a signal can be put into practically any corner of the globe.

To put the rhombics into circuit when and as required, the station has the most complex antenna switch-gear ever constructed anywhere. Mounted on a forest of 20-foot poles are 216 switches, which can be manually operated from the ground, to make any desired connection between the six transmitters and the 24 antennas.

AMERICAN Army and Navy guns of all sizes are blasting the enemy on every war front with more deadly effectiveness than ever before because of amazingly accurate muzzle velocity measurements, as precise as 1/1,000,000 of a second, made possible by a new

electronic time-interval counter developed in RCA Laboratories at Princeton, N. J.

Revealing some details of the device, E. W. Engstrom, Research Director of RCA Laboratories, stated last month that the instrument has been in use for more than a year at the Aberdeen Proving Ground in Maryland and at other Government arsenals and proving grounds throughout the country. It supplies instantaneously information upon which the performance of a given gun is established and the uniformity of its ammunition checked within a few seconds.

Developed especially for the Aberdeen Proving Ground by RCA, the electronic time-interval counter is designed to measure, with great accuracy, a time interval in the order of one one-hundredth of a second. Extreme accuracy is obtained through the ability of the device to give this measurement to within a hundred-thousandth of a second. The research on this device was brought to fruition, and a very practical device made available to the military services through the work of Igor E. Grosdoff, RCA research engineer.

"On the ranges at Aberdeen and at other arsenals, means are being provided for making these measurements at the rate of hundreds of observations a day," Engstrom said. "Each range is equipped with two electrical coils, arranged so that a projectile will pass through them in succession. (See *Radio-Craft*, October, 1944). By magnetizing the projectile, a small electrical signal is generated by each coil as the bullet passes through. If the coils are 30 feet apart, and the time between the two signals is one one-hundredth of a second, the bullet is traveling 3,000 feet a second."

The counter consists of three essential parts: an oscillator, a gate, and the counter proper. The oscillator is regulated, as in a radio transmitter, by a vibrating quartz
(Continued on page 126)



This "forest of switches" directs signals to any part of the world, from the new Voice of America.

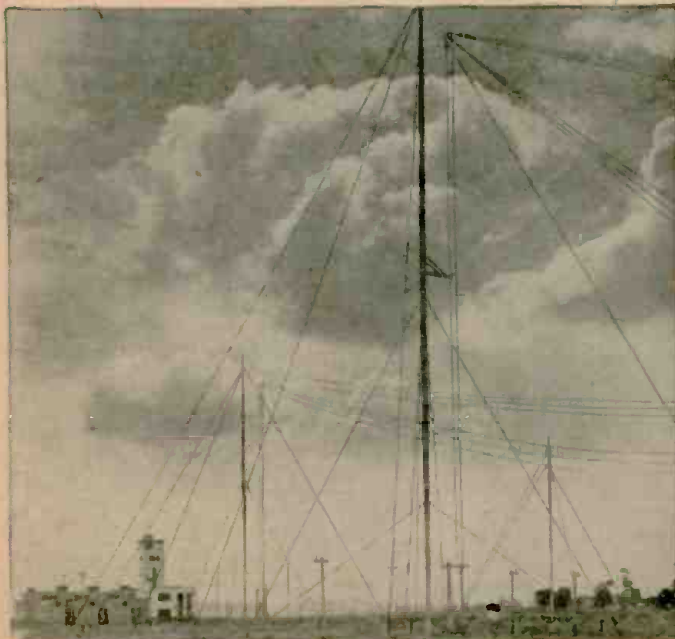

Transmitter house and part of the aerial of the Voice of America.

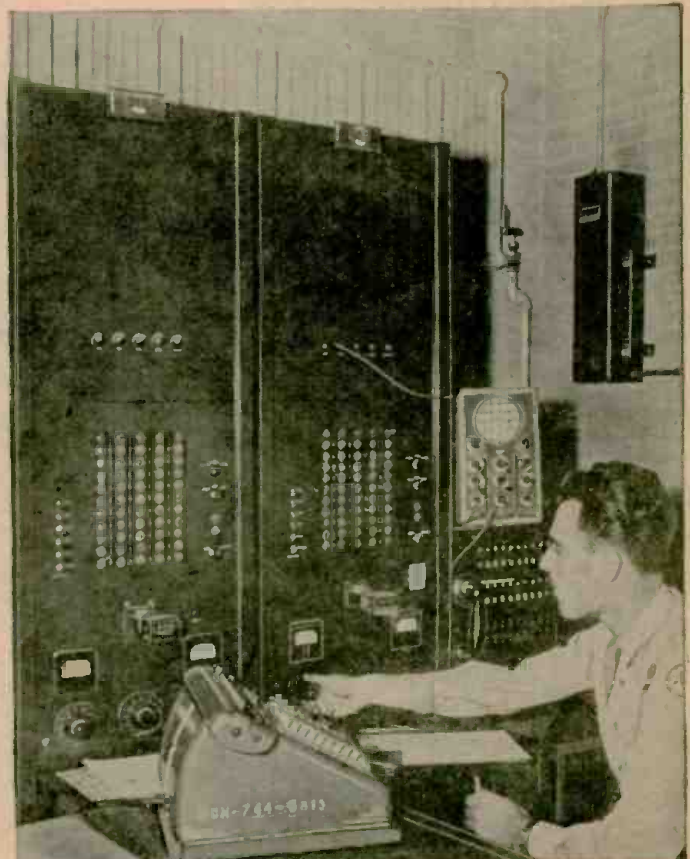

Private John Rhodes takes readings on the RCA chronograph which measures muzzle velocities of guns to the hundred-thousandth of a second. The apparatus is an important contribution to victory.

THE MAGNETIC MOTOR

Recent Advances in Magnetic Current Research

By the Editors of RADIO-CRAFT

SCIENTISTS of America saw "a new thing under the sun" at the Rochester (N. Y.) meeting of the American Physical Society last June. What they saw was not in itself sensational. It was merely a drop of yellowish liquid revolving between the ends of two pieces of wire placed on the face of a small Alnico magnet. Why then were the physicists thoughtful as they looked at this apparently simple demonstration? Simply because modern science knows no reason why the droplet should behave as it did!

Professor Ehrenhaft, demonstrating his new experiment, had an answer. Magnetic current, he said, flows between the pole-pieces, and the droplet—a solution of ferric chloride which bore electric charges invariably associated with colloid solutions—revolved because of the circulatory nature of the electric charge around the magnetic current, analogous to that of the magnetic field around an electric current.

"Heretofore," Professor Ehrenhaft told the meeting, "there were thought to be two general actions in nature—gravitational action and the magnetic action of electric currents. From the second of these actions has come the greatest progress in scientific

Fig. 2—Construction of the magnetic motor. Pole piece may be continuous or in two parts as shown. The liquid is held in a small container around the pole pieces or may be a small drop between them.

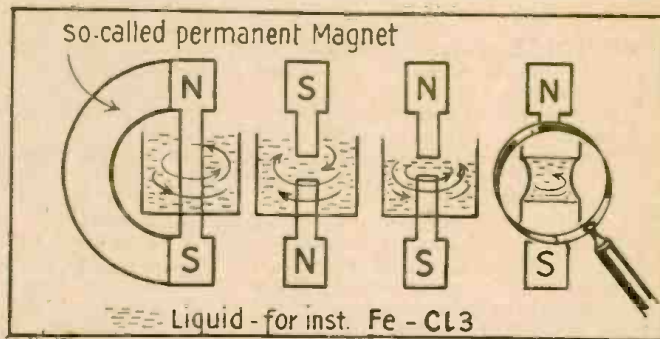

history. Now a third action has been demonstrated—the electric action of magnetic currents.

"I have been demonstrating to your members present a very simple experiment that can be performed by anyone in a short time. I have taken a permanent Alnico magnet, and as you can see, have fitted to it one piece of iron connecting the poles, or two pieces of iron with a gap. I fit to the iron a cup and fill it with a solution bearing electric charges. This solution can surround the uninterrupted wire of iron, or it can surround the gap and both poles, or the lower pole alone—the upper being in air. The liquid may fill the gap alone, either partly or entirely." (See Fig. 1, photo of the magnetic motor.)

"In every case the liquid, or the charged particles in the solution, circulate around the iron wire, or between the pole pieces, as long as there are electric charges. In the case of a solution of ferric chloride, the direction of circulation is counter-clockwise when looking on the face of the South Pole." (See Fig. 2.)

"This is the counterpart of Oersted's experiment. In principle we can draw energy from these masses circulating around the wire or rod connecting the poles. In the utilization of this energy we have the magnetic motor. Energy is drawn from the magnet."

The energy of which the professor speaks is due, he believes, to the circulation of electrostatic charges around a magnetic current, in the same manner as a magnetic "field of force" exists around an electric current. While movement in a non-homogeneous magnetic field has long been known, this discovery of movement of charged particles in a perfectly homogeneous field is new, and constitutes evidence for the existence of a magnetic current.

Let us now consider what this term "magnetic current" means. If Professor Ehrenhaft is correct regarding it—and it looks very much as if he is correct—magnetism and electricity should be reversible. As a matter of fact, that is exactly what Ehrenhaft claims. Note carefully the following (See Fig. 3):

Here we have a storage battery, SB, connected to a coil of wire. As long as the battery is connected, a magnetic field exists in and around the coil. If we insert a piece of soft iron into the coil, it becomes magnetized and stays magnetized as long as the current of the battery is on.

Let us reverse this scheme. Fig. 4 shows what we will find.

Here we have the same coil of wire. Inside of the coil we have a means of introducing a magnetic current. How this constantly-flowing magnetic current is to be achieved is not as yet known. We therefore have shown a question mark in one of the magnetic circuits, which may be composed of iron or some other unknown means.

If Ehrenhaft is right, an electric current—which we can take off at points C and C1—will flow through the coil. This arrangement would then constitute the hypothetical "magnetic battery." As long as the magnetic current flows through the coil, a current will flow at points C and C1.

Again, if electricity and magnetism is reversible, an analogy for the magnetic motor should be found in the field of electricity. This also has long been known. It

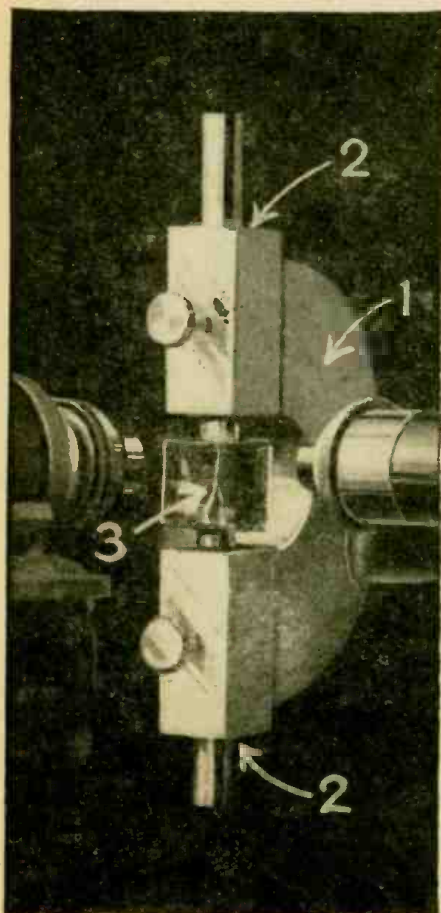
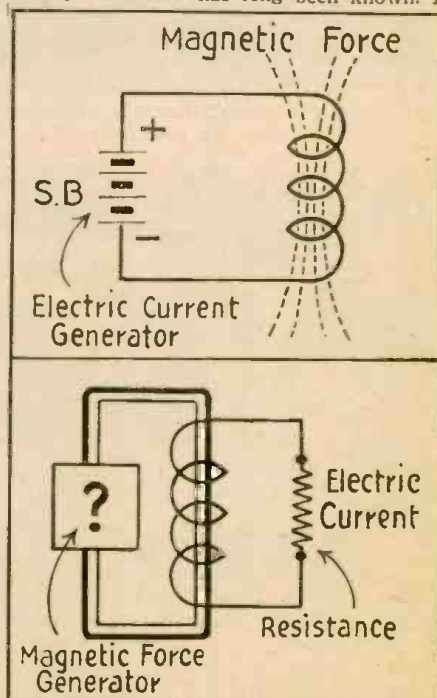
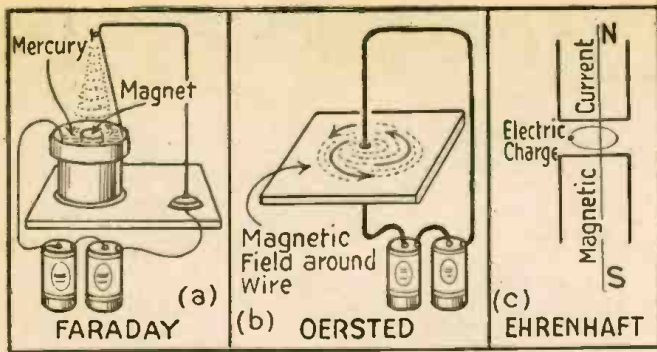

Fig. 1—Close-up of the Magnetic Motor. 1 is the magnet, 2 the pole-pieces, and 3 the container with its circulating magnetic solution.



Figs. 3 and 4—Current produced by an electric generator sets up magnetic force. Conversely, a force set up by the hypothetical magnetic generator should produce an electric current.



is no other than the Faraday motor—a piece of wire with a current flowing through it which circulates around the pole of a magnet in a pool of mercury. (See Fig. 5-a.)

If we reverse the position of the permanent magnet and the current-carrying wire we have the conditions of Fig. 5-b. This is obviously the discovery of Oersted, that of the magnetic field of force around a wire carrying current. Fig. 5-c is the magnetic analogy. Instead of an electric, we have a magnetic current, and around it revolve electric charges.

Referring back again to Fig. 3, note that the magnetized effect of the storage battery, SB, lasts only as long as the battery can supply current. Once it has run down, no magnetic field will exist in the wire coil. But it should be understood that the battery gives out energy as long as its charge lasts.

Conversely, a magnet has also inherent energy—a "charge." This energy is obtained by charging or magnetizing the magnet. So far we have not been able to tap this magnetic energy so that a free magnetic current will flow from one pole to the other, and thus discharge the magnetism of the magnet. But once we have accomplished this, the amount of electrical current which we will obtain from a combination such as that sketched in Fig. 5, will be directly proportional to the amount of energy used originally to energize the magnet.

Not alone by means of the magnetic motor is it possible to draw energy from the permanent magnet. Readers of *Radio-Craft* will remember the description of magnetolysis—decomposition of water by magnetism—which appeared in the March, 1944, issue of the magazine. It is now possible to present photographs of such magnetolysis. As may be seen from the close-up, a U-shaped tube is divided by a glass partition to make it in effect, two separate

tubes. A few small holes at the bottom, plugged with asbestos, permit liquid contact, while keeping gases evolved on each side separate. Two soft-iron pole-pieces—the shape of which can be seen through the glass—are inserted into holes in the lower end of the tube and moved together till they almost touch the glass partition. Rubber gaskets make a water-tight seal. The magnet is placed against the flattened sides of the pole-pieces, as shown in Fig. 6-a and the diagram of 6-b.

The magnetolytic effect made itself known by the fact that with a magnetic field more gas was evolved than without such a field; secondly, that more gas was collected from the North than from the South pole. The North pole was attacked more strongly than the South pole; all this proves—according to Ehrenhaft—that magnetism is polar. The chemical action of iron in acidulated water gives rise to bubbles of hydrogen. When magnetism is applied oxygen is also evolved. Collecting the gas as shown in Fig. 7 it is found that more oxygen comes from the North than the South pole. In two successive runs with the same magnet, the proportions were 1.43 and 1.12%; 0.87 and 0.57%; and another experiment gave 0.25 and 0.16% respectively. Reductions in the strength of magnets after magnetolysis have been observed consistently, such drops amounting around 10% of the original strength of the magnet.

In magnetolysis experiments conducted by Professor Ehrenhaft and Dr. Richard Whitall of New York City, with the electro-magnet, the gases have so far not yet been collected separately. The analysis of the mixture of gases showed 2-12% of oxygen. The amount of absorbed oxygen in the distilled water of the collecting tubes could not account for this quantity of oxygen (as Ehrenhaft stated in Rochester). Furthermore, the control experiment without magnetic field when performed under exactly the same conditions gave 0.00 oxygen. The entire state of magnetolytic research, as initiated by Ehrenhaft, represents of course a first attempt only. In electrolysis it took more than half a century until the first laws had been established and even those are only valid under exactly circumscribed conditions.

Thus it is by no means surprising that one observer reports not to have found oxygen with the magnet; negative reports are likely to be more common than positive until further extensive investigations have been carried on to clarify the situation. The interesting thing is that energy can be drawn from the magnet in two ways. Work is performed when a chemical process is influenced and when rotations are caused around the pole pieces of soft Swedish iron fitted to the permanent magnet.

The cause for recognition of Magnetic Current did, indeed, take a long step forward at Rochester. More than one scientist has been inclined to dismiss the idea, for

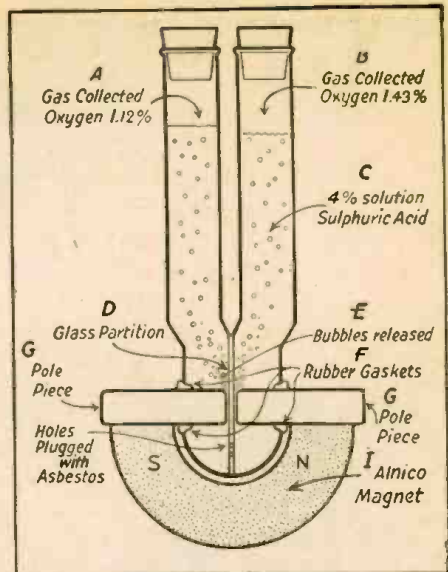

Fig. 6-b—Detail drawing of Fig. 6-a. Letters N and S are the Alnico magnet's North and South poles. Others are explained above.

reasons which are best explained in the words of a British physicist, "It is so completely contrary to the fundamental conceptions of electricity and magnetism that the thoughtful reader must search his mind for other interpretations of the experimental phenomena reported." The Magnetic Motor is also "completely contrary to fundamental conceptions," and the assembled spectators could not readily find any interpretation for the phenomenon.

A second mark of the advance of the new theory is that at Rochester for the first time in the United States others reported that they had repeated Ehrenhaft's experiments with positive results. While certain of Professor Ehrenhaft's students in Vienna had worked along his lines—some of them carrying out original experiments—he has been in the United States a voice crying in the wilderness. Rochester changed all that.

Charles B. Reynolds, of the Federal Communications Commission, New York City, reported that he had duplicated and extended the experiments of Ehrenhaft, and commented on the failure of others who had failed to obtain results while working with set-ups made from newspaper descriptions, which they believed to parallel the

(Continued on page 125)

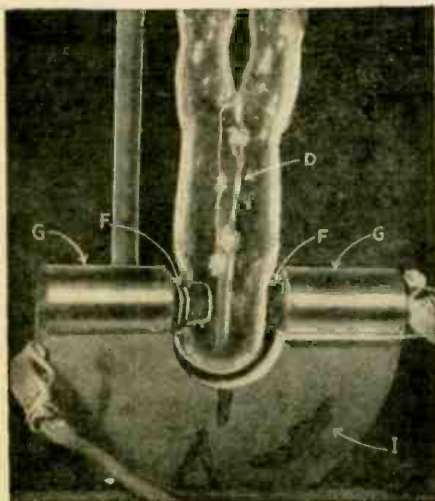

Fig. 6-a—Magnetolysis experiment. Energy is drawn from permanent magnet in the process.

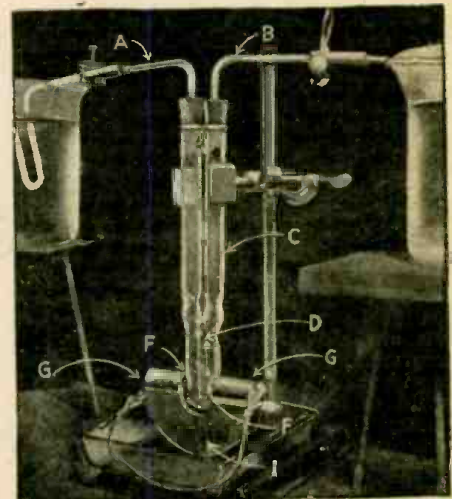
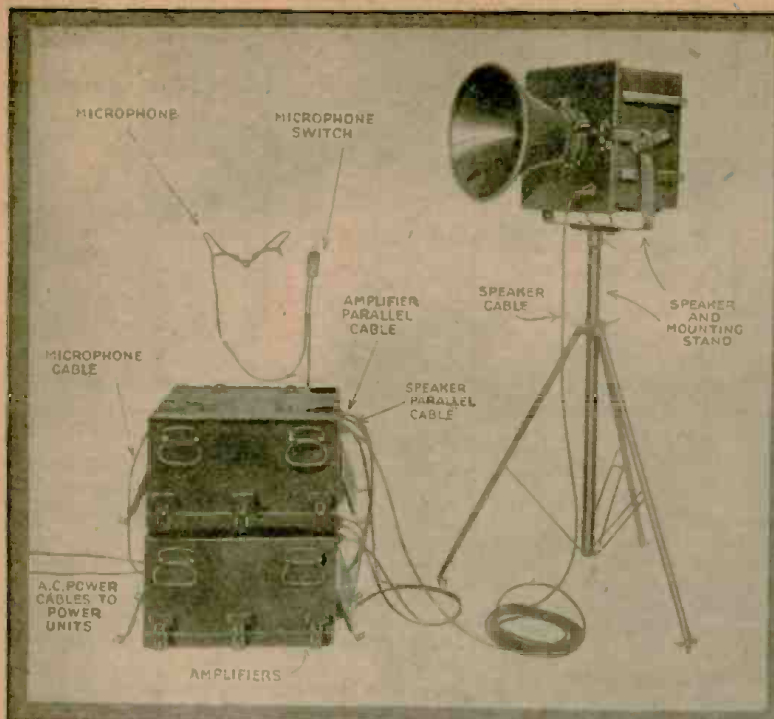

Fig. 7—A complete picture of apparatus used to collect gas in the magnetolysis experiment.



Signal Corps Photos

Photo courtesy of David Bogen Co. and University Laboratories
Above and on our cover is seen the latest powerful P.A. system. Used to invite enemy surrender, it carries the human voice over two miles. At right, two types of sound trucks adapted to the same purpose. The one at lower right was used to effect a Nazi garrison surrender at St. Malo, France.

Cover feature:

Surrender Speaker

By H. GERNSBACK

FOR the first time in any war, modern science has made it possible for the forces of one nation to surrender to an opposing force through the spoken word at a distance, *via* radio amplifiers. It is conceivable that ordinary hand megaphones could thus be used, but this is always a ticklish business because you have to come much too close to the enemy, who may then take a pot-shot at you if he has no intention of surrendering. Ordinary radio means cannot be used because the enemy on the other side does not know whence the radio message originates and he will suspect a trick. But the spoken word which can be heard over a considerable distance, so that a whole garrison can hear, is, for a purely psychological effect, a much better weapon. Indeed, it is often more efficient than guns or bombs. This is particularly true when the enemy, who is surrounded, can be made to believe that further resistance is suicidal and consequently useless.

In the present war, this new psychological warfare weapon has been made use of very successfully not only in Africa, but also in Europe and in the Pacific, against the Japanese. Originally our forces used regulation public address outfits, several of which are shown in our accompanying photographs. These are usually P.A. systems with the customary loud-speaker horns attached to the roof of the vehicle. The necessary electric power is generated by the car engine.

The difficulty with some of these arrangements is that they cannot be used under all circumstances and particularly during battle conditions. When there is a lull in battle and not too many extraneous noises, the

ordinary public address system will serve, but during bombardment or when a new beachhead is invaded, and when hundreds of guns go off continuously, the ordinary public address system becomes useless, because the spoken word can no longer be heard above the din of battle. Nevertheless, some of the older equipment has been used successfully to talk the enemy into surrendering. Thus, for instance, at St. Malo, France, on August 9th of this year, the

THE Schweinheil (HOG CALL)

With characteristic American humor, our G.I.'s abroad have dubbed all Public-Address surrendering outfits *Schweinheils!*

Some mid- or southwest wag from the hog-country, evidently saw a connection between the powerful hog-hail and the stentorian P.A. voice which hails the *Herrenvolk* with demands for their surrender and instructions for coming into the U. S. A. corral.

Germans surrendered because the sound truck personnel used efficient psychology.

This was not always an easy or safe task, because the sound truck had to be moved up within shooting distance of the German-held fortifications. The enemy often could have easily shot up the sound truck in no time. But psychological warfare *via* the spoken word somehow seems to act as a deterrent on the enemy, particularly if

he suspects that his case is lost. Consequently, he holds his fire and in many cases a surrender follows.

Called the "Schweinheil" (hog-call) by American G.I.'s, it is certain that during this war these public address systems will continue to make history, not only inside Germany but in the Pacific, on the Asiatic mainland, and finally in Japan proper itself.

But something more safe was needed by the American forces, both by the Army and Navy. The Navy particularly insisted that they must have a loud-speaker system, powerful enough to carry the spoken word over a distance of two miles during actual battle conditions!

After a good deal of experimental work, extending over many months, such a system was eventually built and is now in use. Not only is it possible to clearly hurl the spoken word over a distance of two miles, but during the height of a battle when anti-aircraft guns are going full blast, when tanks are rumbling around, it has been possible to take down actual word-by-word dictation with every word intelligible over a distance of one to one and one-half miles. That, however, is only part of the story. The loud-speaker, for instance, can be thrown overboard into the ocean because it is completely waterproofed and thus does not sustain any damage if dropped into the sea. The amplifiers are built in sections, two amplifiers being needed for full 350-watt output. Moreover, the entire system—that is, loud-speaker and amplifiers—can be carried by three men without difficulty. For actual field work, the system requires a power truck with gasoline engine.

The 2-mile loud-speaker system as pictured on our front cover and accompanying illustration, has a great advantage over the former short range public address systems

(Continued on page 128)

ELECTRONICS AND AIR POWER

by TED POWELL

PART III

(This prediction was written before the Germans developed flying bombs and jet-propelled planes.—EDITOR)

THE day of true aerial warfare has not yet arrived. That day of the rocket-driven or jet-propelled aerial warship mounting heavy-calibre artillery, rocket guns, massive armor plating, armored turrets, modern navigation and fire-control devices and capable of hurtling high above the stratospheric belts at terrific speeds to unleash 50 to 100 tons of super-explosive, rocket-driven, radio-directed super-bombs from tremendous heights is a thing of the distant future.

Radio-controlled rocket bombs, torpedoes and tanks have already been developed by the Nazi, as well as acoustically-triggered and magnetically-guided torpedoes. A weird and amazing anti-torpedo defense system, a new underwater detection device, new and effective radio signalling devices and gun control systems have been perfected by American ordnance experts.

More and more does the importance and the applications of electronics in modern war grow in extent and importance.

However, Axiom 3 will begin to operate again and the defense will find ways and means to parry the offense and the technological see-saw will continue to swing back and forth as it always has down through the history of Mankind's eternal and bloody game of war.

PREDICTION

The writer will don the proverbial Gernsback cloak of prophecy and venture to make four predictions.

Prediction 1—The Allied air blitz of Nazi Germany will fail to produce a cheap and quick Allied victory.

Axiom 3 will operate here as it has all through this war. The increasingly vicious and effective air opposition encountered by the Allied airmen will testify to this.

The Master At War is improving his defense communications and information centers, A. A. weapons, fighter planes and pilots and his defense tactics. He is concentrating upon fighter plane production and is hiding his plants underground and in camouflage, is spreading his "slave-manned" industrial plants throughout Germany and all of "Fortress Europe."

The Allied military strategists now fully realize that it is a matter of the simplest kind of arithmetic to point out the fact that the Allies can never even begin to hope to build enough planes and bombs to wipe out all of Nazi industry. Only chosen key communications, distribution and production centers can be crippled by air attack. "Superman" or "Buck Rogers" talk of "wiping Germany off the map" is childish dribble. It is an absolute impossibility as things stand today. Again, we must face realities, hard though they may be.

The question of the morale-breaking power of air attacks has also been pretty well settled by now. Psychologists have long recognized the simple fact that the human system is a marvel of adaptability and can adapt itself to the most unbelievable conditions, given time enough. Besides, the Nazi is fully aware of what awaits him, come Victory day. Between these two psychological factors, any hope of a sudden collapse of Nazi morale under aerial assault is more childish wishful thinking.

Thus the Nazi will be beaten only when "The Guys On Two Feet With Guns In Two Fists" land on the continent and help the Reds shatter some 300 well-trained and well-equipped Nazi divisions in a giant hammer-on-anvil offense—the hard and bloody way.

The main Allied blow will unleash the most devastating concentration of destructive striking power ever witnessed by

the eyes of man. American and British mechanized and aerial spearheads will be the giant hammer blows and the Red infantry and tank divisions will be the massive anvil in a giant "nut-cracker" offense.

Prediction 2—Allied seapower is the key to Axis defeat.

In the years to come when historians will have the perspective of time to clarify their military, economic and sociological analysis of World War II, they will write of the dominant role played by seapower in modern warfare. They will write of the mightiest sea armada ever assembled under one flag—the magnificent U. S. Navy and its peerless men-o'-war and their splendid crews—of these complex marine fighting machines and their remarkable control and navigation devices which, with the help of the British navy, smashed all Axis air, sea, and under-sea attacks to keep the tremendously long global supply lanes open and flowing to overwhelm the Axis with an avalanche of specialists, equipment and supplies.

Prediction 3—Russia may emerge from World War II potentially the most powerful nation on the globe.

After the completion of the Red Revolution, a ruthless political machine replaced the backward land-owning ruling class in Russia. A curious world wondered at and feared this radical government and its strange land and peoples.

It so happens that the Russian states are not communist at all but are a well-organized super state-capitalist system. Its leaders and organizers are picked largely on an ability basis and are highly intelligent, resourceful, daringly original and creative, subtly cunning and utterly ruthless when need be.

The world criticized or laughed at them when they trained workers, women and

(Continued on page 116)

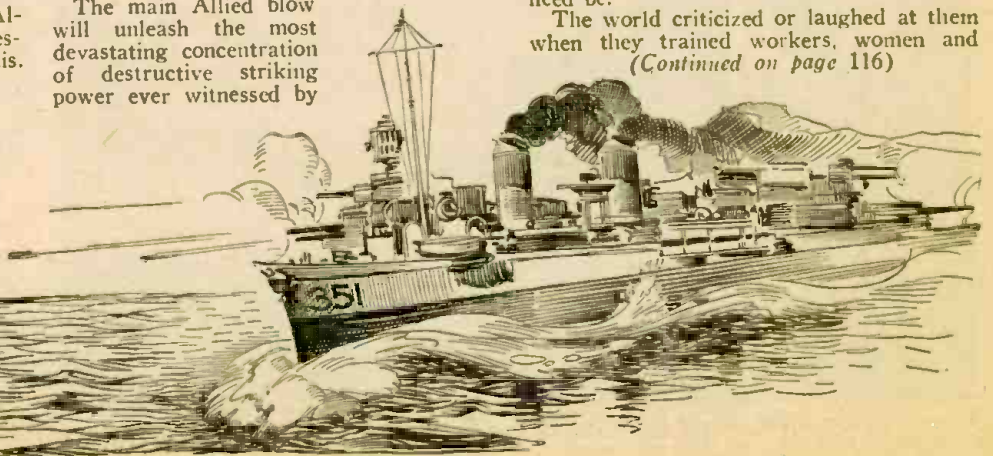
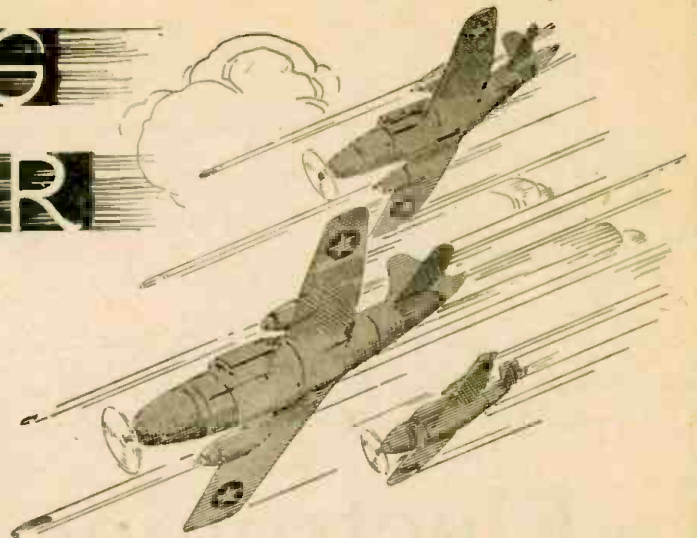

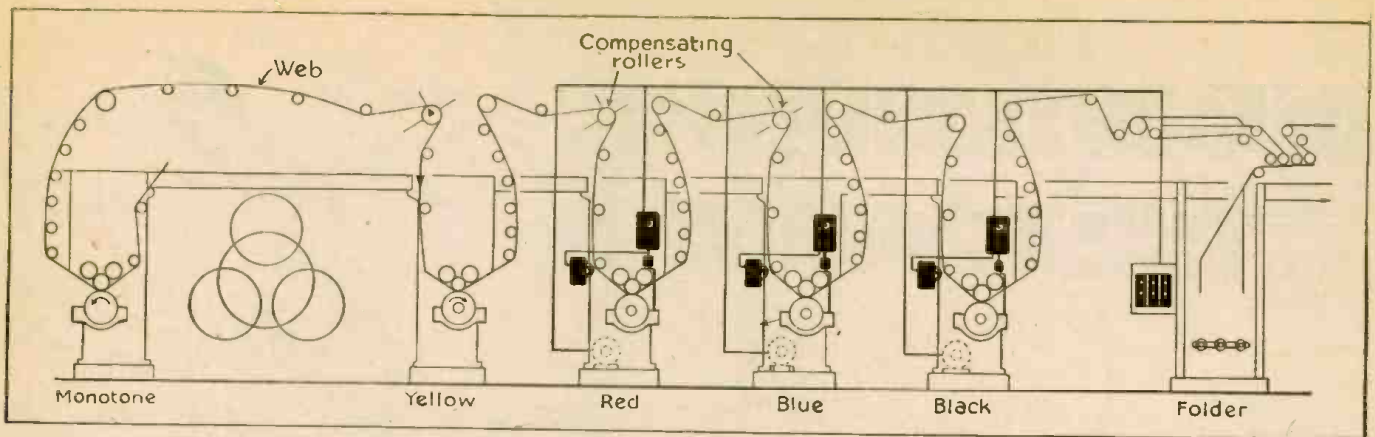

The path through a color-printing press is a long and tortuous one. If the paper stretches slightly, off-register printing will result.

Electronics and Printing

By PHIL GLANZER

WERE hearing a lot these days about what Electronics is going to do in the world of tomorrow—how it is going to open up whole new vistas for the application of science in industry, how it will speed the development of new products, new techniques, new super labor-saving devices to release untold thousands of workers for useful jobs in other lines. We're hearing too, about how Electronics is helping to win the war now on the battle front with fabulous Radar and secret communication devices and on the home front in dozens of war industries by speeding up production and reducing waste.

What we haven't heard so much about is just what this magic Aladdin's lamp of science is doing in your own backyard—the printing industry. Its actual achievements here are as remarkable as in the better known field of war production. And its future possibilities in this one corner alone have scarcely begun to be realized.

Today Electronics has solved some of the toughest pressroom problems known to

printers. With high speed 4 and 5-color rotogravure presses it has cut spoilage to a fraction of former figures; it has speeded production to an amazing extent, and it makes almost blamelessly perfect register a matter of routine for runs of hundreds of thousands!

Don't lose interest because these achievements concern only one field of printing, rotogravure; and then only high-speed web-fed presses. You just can't afford to sell Electronics short at this stage of its amazing development. You may wake up some fine day to find that its magic eyes have been applied to other types of presses, that it can be profitably used to solve problems in other branches of printing. Now is the time to get acquainted with Electronics in printing.

ROTOGRAVURE HEADACHES

Let us start by reviewing some of the problems that rotogravure pressmen have

had to face and solve as a matter of routine printing before Electronics took over.

A well-registered job requires an accuracy down to *one-thousandth part of one per cent*. Paper on a rotogravure press moves at a speed up to 1,000 feet per minute. This paper may rapidly change its dimensions by a whole percent or more, because of changes in humidity and tension.

Further, temperature and other factors may cause still more variation in dimensions in between the time the paper leaves one color unit, passes over drying drums and compensator rolls for 20 feet and then is led to a second printing cylinder.

Small wonder that it has been found necessary to control rigidly every factor that might cause a change in the length of paper between printing cylinders. The paper is especially made to provide minimum stretch. Even then dimensions vary, due to uncontrollable manufacturing conditions, although this variance has been cut to a minimum and made to stay within narrow limits. It is stored under conditions of regulated humidity. But the air in the pressroom itself, or even while on the press during printing, may cause a variation. Special equipment is provided on the press to insure nearly constant tension. The press is run at as constant a speed as possible.

All these precautions and others, make the operation of multi-color, high speed, gravure presses not only possible but practical. But it has always been necessary for the pressman to be ever on the alert to correct mis-register before spoilage resulted. Even under such conditions, it has been impossible to hold register through splices or during periods of acceleration and deceleration, in which the paper tension was changing appreciably.

SCIENCE STEPS IN

It was at this stage that research specialists stepped in. They thought that Electronics might be put to work doing the job of register.

It was logical to expect, they reasoned, that if an electronic eye could watch and record printing just before it reached the next cylinder, any effect of a change in paper specifications might be eliminated and the register itself controlled. Another advantage would be that the "eye" could see the mis-register at the instant it occurred, giving warning, and thus the pressman would not have to wait until the finished print job came through the folder before the mistake was detected.

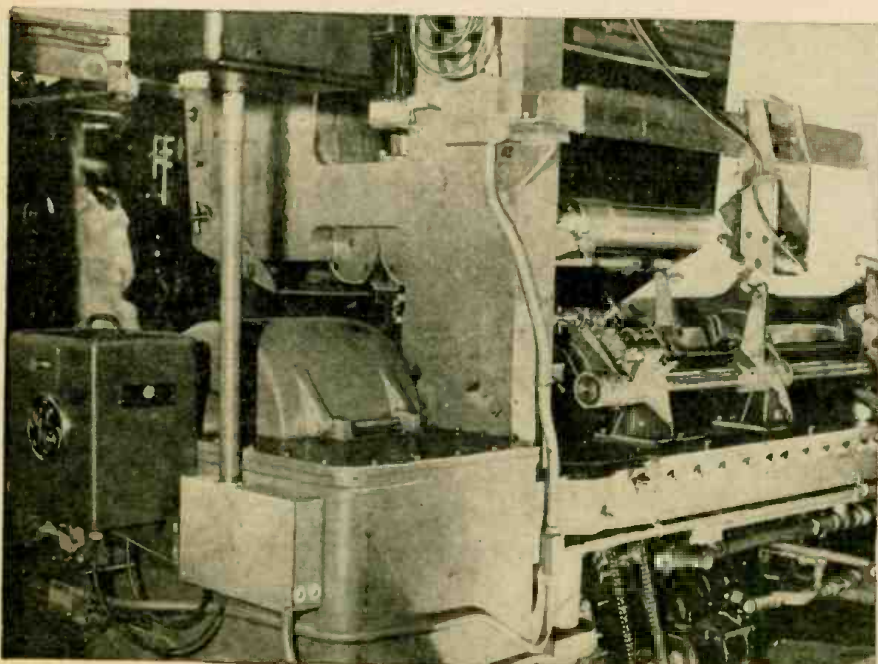

A modern printing press fitted for electronic register control. The timing mechanism may be seen in the box marked "G-E" (General Electric) mounted on the shaft end.

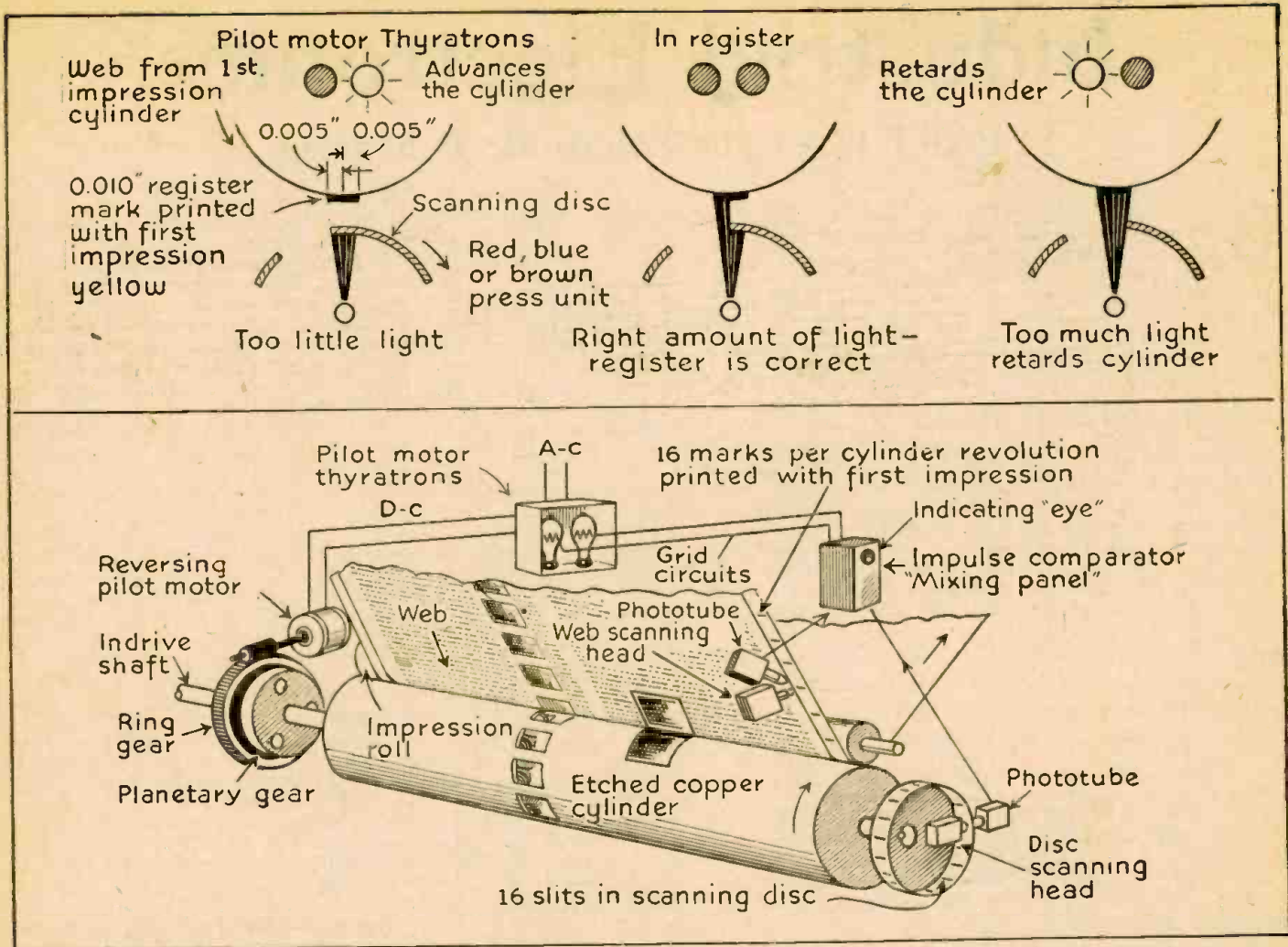

Above—How variation in the amount of light falling on photocell controls cylinder. Below—a sketch of the whole registering operation.

This is just what the engineering experts proceeded to do. Two requirements were laid down as being fundamental for color register. First, the control must determine accurately the relative position of the previously printed matter and the printing cylinder to be registered. Second, it must apply an adjustment to the cylinder or the sheet in the right direction and amount to correct the mis-register.

REGISTER MARKS

In actual practice a series of register marks are etched in the first color cylinder, usually the yellow. These are inconspicuous and are about 0.020 inches wide and 1/2 an inch long across the sheet. They are located in the margin or fold, if possible, in a clear track away from other printing. Most readers are entirely unaware of the presence of the register marks until these have been pointed out to them.

Scanning heads to view these marks are then placed as close as practical to the other cylinders to be registered to this color. Since all other cylinders are registered to this color, they will, of course, be registered correctly to each other.

The position of the printing cylinder is indicated by a disc or drum which is attached to one end of the cylinder shaft, and which contains slits accurately spaced to correspond to the position of the register marks on the paper. Another phototube views light projected through the slits, thus producing an electrical impulse which is compared with the register mark past the first phototube. It is the usual practice to place 16 marks around the circumference of a typical 43-inch cylinder.

The impulses from the cylinder photo-

tube and the web phototube are fed into a "mixing" panel where they are compared. In this mixing panel, the signal from the passage to the cylinder disc slit causes a second signal to be set up, which occurs immediately after the slit signal has finished and which is approximately as long. Thus, if the web signal occurs during the same time as the signal from the slit, it indicates that the web is too far advanced and a signal is set up to retard it. If the web signal occurs during the time of this new trailing signal, the web must be advanced. However, if the web mark passes so that it divides evenly between the slit and trailing signal from the cylinder, the advance and retard indications are balanced and no correction is necessary.

AUTOMATIC SIGNAL

Where an indication of mis-register is given in the mixing panel, a signal indicating the amount and direction of correction needed is immediately generated and transmitted to the motor panel.

It is important to note that the register is held between the center of the web mark and the trailing edge of the cylinder disc slit. Thus, the intensity of light through the disc slit, the color of the printing, or the depth of the etching or doctor-blade setting have little effect on the position of register. The phototubes scan the mark and slit through optical systems similar to those used on telescopes and gunsights. This not only insures an accurate and permanent setting, but also, since the image is magnified four to five times before it reaches the phototube, makes possible an accuracy of indication of 0.001 in. or 0.002 inch without the use of extremely narrow slits.

Since the presence of the web register mark is necessary for a correction indication, if one or more marks should not print for any reason, the equipment simply ceases to operate and cannot cause a false correction, which may lead to excessive waste before it is detected.

MAKING CORRECTIONS

The next step is to correct the mis-register which has been found. To do this, the thyatron, big brother of the receiving tube, is used to operate the correcting motors. Thyratrons may be operated from the small signal voltage produced by the mixing panel, and in turn can control the power required to drive a one-half horsepower motor.

Gear motors are used to obtain the desired rates of correction. This is found to be between 1 in. and 1 1/2 in. per min. Greater speeds than this may cause the paper to be torn.

Once set, the register should hold quite closely to the set position throughout the run. Rapid acceleration, deceleration, or a splice may cause the paper to be jerked or to lose tension suddenly and permit the register to go out of range. However, the photoelectric equipment will bring the sheet back into register much faster than possibly can be done by manual control. The press crew is free to concentrate on jobs requiring more skill and judgment.

Here, then, is how Electronics has taken over in one field of the printing industry. Its powers, long latent in laboratories and research clinics, have once more been harnessed to do an almost incredibly delicate and accurate task quite automatically and as a matter of routine production.

Industrial Electronics

PART IX — The Electronic Policeman

By RAYMOND F. YATES

THE whole story of property protection by the use of electronic equipment cannot be told today. The war has developed many ingenious devices for the detection of the eavesdropper, spy and plain thief which must remain secret at present. However, enough is known to make a most interesting survey. Even a modest estimate of future possibilities is full of meaning for the man who has decided to cast his lot with the future of the fascinating electronic art.

It was perfectly obvious that the first practical use of photocells carried with it the inference that here, too, was a practical device for use in burglar detection. The first applications in this respect were made some twenty-five years ago. While no actual figures are available as to the number of such installations at the present time, they are

many photocell alarm which may operate either with visible or invisible light; second the inductive or electromagnet method as exemplified by the Hughes induction balance previously referred to, and finally the electrostatic method where "body capacity" may so affect a circuit as to close a relay and ring an alarm.

The electrostatic, or "body-capacity" system (see Fig. 1) is now widely employed in the protection of safes and other metal cabinets holding valuable papers. This system is extremely suitable and it already has been responsible for the capture of a number of would-be thieves. The mechanism is simple and foolproof.

of the system in such a way as to release the alarm system.

This system is flexible and relatively inexpensive. Only low power is needed. Each unit may cover five or six hundred feet of ground, the alarm area extending ten feet on either side of the suspended antennae. Where extensive properties are to be protected from unauthorized invasion, a number of such systems are installed and a central indicating office is established. The safety of the prowler is becoming more uncertain every year.

The electrostatic protection method has found wide use during the war and hundreds of men, otherwise needed as guards, have been released for more productive war service. Indeed, some small plant managements have placed so much faith in the electronic watchman that flesh-and-blood police have been given other jobs.

The most modern applications of the purely photoelectric method of burglar or prowler protection does not involve the ordinary photoelectric cell, which is not successful in this type of service. For one thing, the use of an intense beam of light helps to defeat the purpose of the system. Thus photocells especially sensitive to infra-red rays are now employed widely in such systems. These provide not the slightest hint of their presence. Systems based on such tubes have a high degree of sensitivity and are very reliable.

When a method of this sort is employed, it has been found that the beam length should not exceed one hundred and fifty feet. Beams may be used with mirrors for criss-cross illumination of photoelectric targets, as in Fig. 2, but this is not quite as easy as it sounds. The trouble is that each mirror employed reduces the intensity of the light beam approximately 50%. Thus there are distinct limitations as to the size of the area that may be covered by a single cell and reflecting system. As many as 500 linear feet, however, may be covered by a photoelectric system of modern design. Criss-cross coverage where large areas—inside or out—are to be protected must employ two or as many as twenty separate units.

Although we did not mention it earlier in the chapter, it is true that sound detected by electronic devices may have important bearings on the subject before us. This may go not only for detected sound but for electronically generated sound as well. Already Rochelle salt type pick-up units are employed on wire fences surrounding factories. When a fence is being tampered with these generate current which is amplified and used to close an alarm circuit.

This may not be the end of sound in this work. The future of super-sonics as related to the protection field looks promising indeed and we may expect many improvements. Already work is going on to develop a super-sonic method incorporating sounds of 30,000 c.p.s. to produce standing waves or wave-energy beams. Even sounds of ordinary frequency are being employed in the protection of vaults and safes.

The coming reign of the microwave will doubtlessly leave a mark on the new science of electronic protection. With the microwave, large properties could be so completely interwoven with a vast system of waves that a person would not be able to

(Continued on page 123)

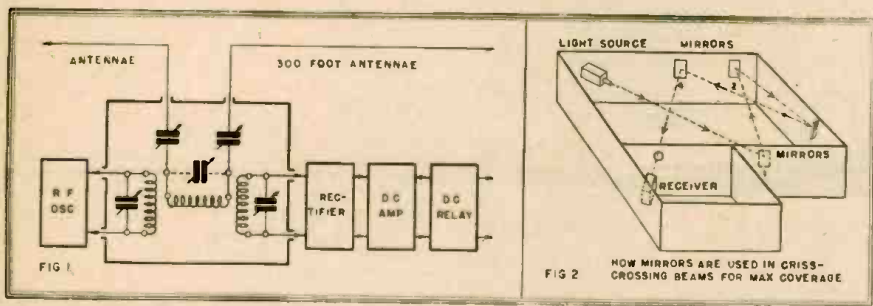

Fig. 1—Electrostatic intrusion detector. It operates by detuning an oscillatory circuit. Fig. 2—A photoelectric approach to the same problem. Breaking light ray sets off alarm.

numerous and cover a wide field; extending indeed all the way from Sing Sing prison to Fifth Ave. In fact, Sing Sing made the first practical use of the photocell as applied to penal institutions. The scheme was simple enough. A beam of light ran along the tops of the walls in the prison yards and roofs. Breaking the beam rang the prison alarms.

But this does not by any means end the story of electronics as applied to burglar detection or prison guarding. Other electronic devices have been placed in this and associated uses. A refiner of rare metals installed a modified Hughes induction balance which was extremely sensitive to the presence of even small amounts of conducting materials. A man passing through a doorway which carries one of the balance coils in its frame will not register unless a metal is present on his person beyond a point normally carried.

Apparently, we have at least three commercially acceptable methods of electronic protection. First there is the (now) ordi-

One of these electronic-electrostatic methods involves a low-power V.T. oscillator tube connected to a safe which is in turn insulated from the ground. Thus the electrostatic system uses the earth as one plate of the condenser and the metal cabinet or safe forms the other. A person entering this electrostatic field upsets the balance of the circuit and an amplifier supplies enough current to operate a relay for the audible alarm.

The above system is in some instances replacing the photoelectric system in the policing of large fence-inclosed properties. Naturally when large expanses are covered, a point is soon reached where the photoelectric cell is not too practical because of the great difficulty of generating a beam of light powerful enough to cover long distances. With the electrostatic method, an antenna wire runs along the top of the fence or may merely rest on poles without a fence. In any event, a person approaching within a critical distance will affect the capacity

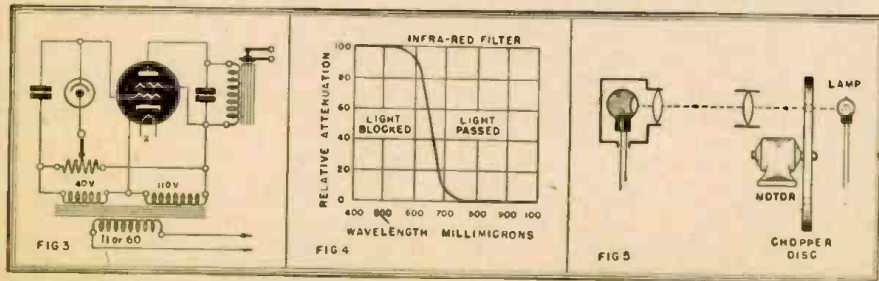

Fig. 3—Circuit of a photoelectric relay. Fig. 4—Response curve of a filter for blocking out visible light. Fig. 5—An improved circuit in which a modulated beam is applied to the cell.

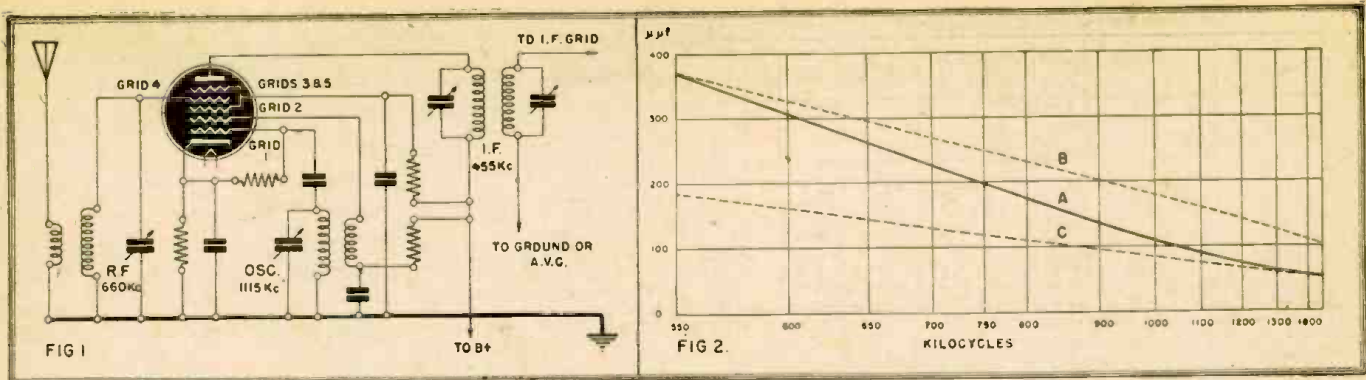

Fig. 1—Mixer stage of simple superheterodyne

Fig. 2—First attack on the tracking problem

The Tracking Problem

How to Master the "Unalignable" Superheterodyne

By ERIC LESLIE

NUMEROUS abandoned sets are now being modernized and put into action, often by "cannibalizing" parts from other radios; TRF's are being turned into supers; and no few constructors are "rolling their own," in some cases winding their own coils, in others taking them from old receivers.

Too many of these amateur engineers get unexpected results from their completed jobs. Some of their receivers bring in stations at one end of the dial only, others tune correctly on the high frequencies, while stations are far from their correct markings on the lower ones. The opposite trouble may be found, or all stations may be faint and crowded together in one small section of the dial. The constructors are often sorely puzzled.

The reason for their troubles is that a superheterodyne includes two distinct circuits tuned to different frequencies. These frequencies must be a definite distance apart at all points on the dial. Unless a set is carefully constructed and adjusted, this distance is not maintained—the set does not track—and such stations as are tuned in are the result of accident, when the orbits of the two circuits cross each other or come close enough to permit reception.

MIXERS AND MIXING

In its simplest form, a super starts out with a mixer tube, which is really two tubes in one envelope. See Fig. 1. One section of this tube (cathode, grid 4 and plate) acts like an ordinary R.F. amplifier. The coil and condenser connected to it are tuned to the frequency of the station received. The other section (grids 1 and 2) acts like a triode, and is connected in an oscillatory circuit tuned to a frequency usually higher by a definite number of kilocycles than the station being received. The screen-grid and plate circuits are shared by both sections of the tube. Consequently two R.F. currents flow in the plate circuit. One of these is at the frequency of the station being received, the other at the frequency of the "local" oscillator. These two are truly mixed in the plate circuit. The main result of the mixing is the appearance of a third frequency, which is equal to the arithmetical difference of the other two, and changes in strength with any variation in either of them. The signal from the oscillator section is fairly constant—that from grid 4 is modulated by the broadcast station, so the difference frequency (or beat frequency)

is similarly modulated. An I.F. transformer in the plate circuit is tuned to the frequency of this modulated signal, and rejects or shorts the others.

If the difference frequency is 455 Kc. (as on many modern supers) and the I.F. transformers are tuned to that frequency, it is apparent that the oscillator must be tuned to 455 Kc. above the frequency of the station to be received. (It could be 455 below, as well, at the cost of making tracking problems worse.) To receive a station at 600 Kc., the oscillator must be tuned to 1055 to produce the correct "beat" frequency for the sharply-tuned I.F. transformers. If the R.F. section is tuned to 650 Kc., very little of the 600-Kc. signal will get through to the control-grid of the mixer, and weak or no reception will result. The R.F. must keep in step with the oscillator, and 455 Kc. below it, all across the dial, for satisfactory reception.

WHERE THE TROUBLE LIES

These two circuits are usually tuned by one "gang condenser," so it is necessary that they be designed to "track" closely together. This is not easy. In a TRF set, all stages are tuned to the same frequency at the same time, and the only problem is to make all coils the same size. The two circuits of the super must be tuned to two different frequencies, and the difference between them must remain the same over the whole dial.

The difficulty is illustrated in Fig. 2. Curve A is made with a 365 (maximum) micromicrofarad variable condenser and a 230 microhenry coil. The frequency is 550 Kc. with the condenser at 365 μmf and 1450 at 50 μmf. The oscillator circuit of the set must be so designed that, at any given setting, the oscillator frequency is 455 Kc. higher than the corresponding resonant frequency of the R.F. circuit.

A capacity-inductance table shows that to tune to 550 plus 455 Kc. with a 365 μmf. condenser requires a coil of 70 mH. (Values are approximate, having been taken with a table and a slide-rule, but are accurate enough for our purposes). When the condenser is turned down to 50 μmf, the resonant frequency of this combination is 2500 Kc., not the 1905 we would like to have. (See curve B, made by subtracting 455 Kc. from the curve of the 70mH-365

mmf combination, to show how close it comes to perfect tracking.) Only one or two stations close to 550 Kc. could be received with such a combination.

The attack might be made from the other end—the high-frequency one. To tune to 1450 Kc. with 50 μmf. capacity requires a 144 mH coil. Curve C—made the same as curve B—shows how that would work out. Constructors who received only high-frequency stations on their radios will see what caused their troubles.

HOW TO MAKE CIRCUITS TRACK

The trick is to find some means of making the oscillator tuning curve lie exactly 455 Kc. above that of the R.F. coil-condenser combination. Experience with superheterodynes has already taught us that this can be accomplished by means of semi-variable condensers. An ordinary trimmer would be of little value to us, as can be seen from curve C. To make the oscillator track at 1450 Kc. would require almost exactly 50 μmf. trimmer capacity. Should we add that capacity by screwing down the trimmer on the oscillator section of the condenser gang (supposing we had such a big trimmer) curve B would merely be lowered by 50 μmf. right across the chart. Tuning would be out by 50 μmf. at 550 instead of 1450 Kc.

There is another adjustable condenser on most superheterodynes—the paddler. This is in series with the oscillator variable condenser. Fig. 3-a shows the arrangement. It does not always look so simple. The paddler on the broadcast band is usually made up of a fixed mica condenser with a trimmer shunting it, and schematics sometimes look like Fig. 3-b. The paddler is 1; the oscillator section of the gang, 2; the

(Continued on following page)

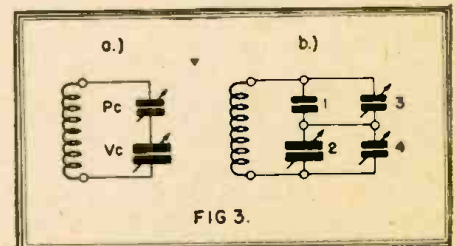

FIG. 3.

Fig. 3—Most supers use padders, which may be represented in one of the styles shown above.

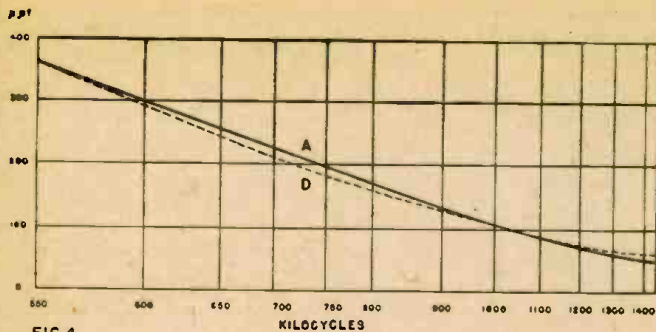

FIG 4

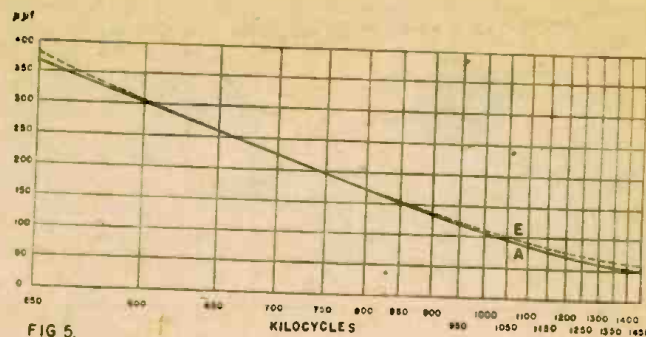

FIG 5.

large trimmer across the padder, 3; and the trimmer on the gang, 4. The circuit is only that of Fig. 3-a with a trimmer across padder and tuner.

HOW THE PADDER WORKS

If two condensers are connected in series their joint capacity is smaller than that of the smaller one. This capacity cannot be arrived at by simple addition, but is expressed by the formula:

$$\frac{1}{C_1} + \frac{1}{C_2} = \frac{1}{C \text{ resultant}}$$

With this formula we can select a padder that will make the 144 mH coil and 365 mmf. condenser track at the low-frequency end of the band. According to the coil table, 176 mmf. is needed. Subtracting 1/365 from 1/176

$$\left(\frac{1}{C_1} - \frac{1}{C_2} = \frac{1}{C_1} \right) \text{ gives } 1/350 \text{ approxi-}$$

mately as the reciprocal of the padder size. Using a 350 mmf. padder, we get curve D (Fig. 4). A is our original R.F. tuning curve. Note that the padder throws tuning off only slightly at the high-frequency end, where it is much larger than the tuning capacity.

This is a great improvement. A set so lined up would work, though signals would be weak in the 650-850 Kc. region. It might be more effective to make the coil a little smaller, so that the two curves would coincide near the middle of the band. The padding condenser could then be made a little bigger to bring the curves together at some point near 600 Kc. and the trimmer could be adjusted to bring them together near 1400.

By varying the size of the coil, the padder and trimmer, it is possible to have the frequencies of the two coils in exactly the right relation at three points—near the top, middle and bottom of the band, and to stray very little at any intermediate point. Fig. 5 is made with a 130 mH coil and a 390 mmf. padding condenser. The tracking is almost perfect from 600 to 900. From there the two curves spread slowly apart. The trimmer can be adjusted at 1400 to bring them exactly together.

Because of the padder, a change in the trimmer capacity will not throw the tuning out as much at low-frequency points as it would in circuits without a padder. It requires about 9 mmf. to bring the two curves together at 1400 Kc. At 800, this extra capacity makes a difference of a little less than 5 mmf., and its influence rapidly disappears as the condenser is turned still further "in."

In actual practice, with two adjustments of trimmer and padder, the two curves can be kept close together practically from one end of the dial to the other.

THE PRACTICAL METHOD

The foregoing discussion is of little help to the person who has a set which fails to

track, except as it acquaints him with the reasons for his difficulties. Fortunately, it is even easier to trim up a set of coils than to read about why they need such trimming. All that is necessary is to free from the calibrated tuning dial all circuits but the one you are interested in at the moment. Each circuit is thus adjusted independently of the others.

The first step is to be sure that the I.F. is correct. This requires alignment with a good signal generator. (If you have none, have a serviceman do the job.) The signal generator is also useful in adjusting the coils, but not absolutely necessary, if you can identify a number of stations in different parts of the band. All that is needed is a variable condenser of capacity approximating that of one of the sections of the gang in the set.

Mount the new condenser firmly on some part of the chassis, or if impractical, make a good connection from its frame to the chassis and put it as close to the set as convenient. Then move the coil and grid connections from the stator of the R.F. section of the gang to the new "independent variable." Now the oscillator and the oscillator alone is tuned by the calibrated dial on the set.

Set the dial at 1400 or thereabouts, and rotate the independent condenser. If the oscillator is tuned to a station it will be picked up at some position of the R.F. tuning condenser. If not, move the dial a degree or two and try again till one is tuned in. Identify the station and check its dial marking. If only slightly high or low, the oscillator coil may be the right size. If so, bring the dial to the correct point with the trimmer, the turn to a station near 600 Kc. and adjust again, as in ordinary set alignment.

ADJUSTING THE OSCILLATOR

If the oscillator coil is too large, stations will tune in at much too high a figure on the dial—if too small, at too low a figure. Should the coil appear too large or small, it is a good idea to screw the padder down pretty well, tune in a station between 800 and 1,000 Kc., and add or take off turns till the dial reads correctly. Then tune in a station near 1400 and adjust the trimmer till the dial is correct, afterward tuning in a station near 600 Kc. and adjusting the padder till the dial is also correct on it. Tune over the dial again, retrim and repad, possibly adding or taking off another turn or two for uniform tracking. Check again to see that all stations come in on the right dial setting.

To adjust the R.F. section, move the leads from the stator of the oscillator section of the gang to the independent condenser and put the R.F. leads back in their place. You will see now why the curves do not have to lie exactly on top of each other. The R.F. section tunes rather broadly. Turning it a degree or so off maximum signal makes little difference in the strength.

Bring in the station near 1400 with the independent condenser and note whether the

R.F. circuit is nearly correct or not. If reasonably close, adjust to the exact point with the trimmer and move up to the station near 600. If it is not loudest at its proper dial setting, add or take off turns till it also tunes in at exactly the right place. Correcting the R.F. section is easy compared to getting the oscillator lined up.

Bad tracking may occur because of wrong-size padding condensers rather than coils. If the padder is too large, stations will be crowded and displaced toward the high-frequency end of the dial, only those near that end being tuned in near their correct dial markings. If too small, the displacement is in the other direction, and stations are spread apart. A larger or smaller padding condenser is the remedy, of course.

Once the reasons for its action are understood a rebuilt super is not hard to adjust. If you follow the above method you can even wind your own coils with a fair chance of success.

WOMEN AND POSTWAR RADIO

A QUESTIONNAIRE survey recently completed by *Woman's Home Companion* disclosed the following statistical facts regarding home sets: 97% of those questioned own at least one radio. In the upper income groups radio ownership is nearly 100 per cent, in the lower income group it is 89%.

49% have one radio, 37% have two radios and 10% have three. Altogether 1608 radios were found in 931 homes, or 1.7 radios per home.

54% of the radios in use are table models, 30% are consoles, 10% radio-phonograph combinations and 6% are battery portables.

71% have at least one table-model, 49% of the radio owners have console sets, 16% have combination radio-phonographs, and 9% have battery portables. The console and combination radio-phonograph are invariably located in the living room, the battery portable is carried from room to room, but its most frequent resting place is in the bedroom.

35% of the respondents have a record player in their home. Of these, 45% are combination radio sets, 43% phonographs, and 16% are phonograph attachments to the radio. 22% of radio owners reported at least one radio out of order. 15% of all radios are not in satisfactory working condition. 65% plan to buy a radio after the war. The biggest demand in post-war radio buying will be for the radio-phonograph combination. Of those who plan to buy a new radio, 57% want this type of set. 22% plan to buy a table model, 21% a console, and 3% answered "television."

In buying a radio, tone is the primary factor, 80% considering this quality first, then comes the reputation of the manufacturer 16%, and third appearance 4%. While tone was overwhelmingly first in importance, radio owners indicated that manufacturers' reputation and the receiver's appearance play a decisive part in the choice of a radio when the tone of competing radios is practically equal.

Oscilloscopes In Industry

PART II—VIBRATION, AIRCRAFT AND MEDICAL APPLICATIONS

By WERNER MULLER

MANUFACTURERS of power transformers can well use the oscilloscope to advantage. Relationship of windings in respect to phase angles and voltages in primary, secondary and tertiary circuits or between any one of these are simple to find. Losses due to hysteresis, magnetic flux and mutual inductance are also easily observed. Thus the desired theoretical calculations can be checked visually; compared and corrected where necessary.

Transient surges, due to action in any circuit from applications such as welding, rectifying, etc., will show the time and frequency of the occurrence by simple means. Steps for protection can then be made. Fig. 6 shows phase angle measurement and Fig. 7 the set-up for transient observations. Other applications in the electrical field can be as easily covered and processes for bettering performance and service for any apparatus increased, to the advantage of the maker and the consumer.

STRAIN, STRESS AND VIBRATION

The field of physics is particularly suited to the oscilloscope. Problems encountered in research, development and performance are speedily observed and possible calculations elucidated. Vibration study is an important branch of physics. The oscilloscope is of inestimable value in this work, since the exact nature of the motion can be seen and interpreted or recorded.

Fig. 8 shows a method for measuring strain and stress in metal. As mentioned earlier, a specific form of carbon in strips is used. The carbon strip has the property of developing small voltages across it, due to variations in its resistance when subjected to any minute strain or stress developed mechanically across its length. These voltages can be observed on a scope and recorded. In some cases photographic records are made for analysis. Some forms of crystals can be used in place of the carbon strips. The choice of use depends on the subjects studied and opinion of the research worker. Fatigue tests of metals are thus recorded. Temperature measurements are also possible with the oscilloscope, although the set-up required is of a complex nature.

Metallurgy can utilize the oscilloscope for measurements of strain and stress, conductivity, reluctance tests, magnetic effects, resistance, and a number of other uses.

In chemistry the observation of voltage and currents through various forms of matter, solids, gases, fluids can be simplified by the use of the oscilloscope.

The nature of the wave forms encountered when dealing with matter, being observed and recorded, can well spell success or failure of an experiment in many cases. Fig. 9 shows an idea to be used in noting wave form through gaseous conductor. Similar connections are possible with other matter.

In the aircraft industry the use of the oscilloscope cannot be underestimated. Its prime spot of importance lies in conjunction with vibration measurements.

Synchronization of engines, firing of spark-plugs or timing observations and no doubt a host of other applications are possible. In any of these instances the assistance of the oscilloscope will further the facility of testing, troubleshooting and correction during manufacture. Vibration tests can be made as outlined under the applications in physics. The timing of propellers or synchronization of same can be made through electronic switches and similar set-ups. Spark-plug and generator tests are similar to others outlined.

Watchmakers can use the oscilloscope to advantage in determining the performance of the "second-wheel" movement. Erratic operation can be noted, timing can be provided against the 60-cycle standard and errors can be corrected in a fraction of the usual time. This holds especially true in production line tests. Fig. 10 shows a test line setup using an electronic switch, 60-cycle standard and oscilloscope with crystal pickup for quickly testing watches. The man-hours saved by this method can be readily evaluated against other methods.

MANY MEDICAL APPLICATIONS

Medical Science in the past few years has also adopted the oscilloscope in a number of instances. The results achieved have been well worth the efforts, since new tests have been possible that permitted the observation of brain waves, pulse wave, form of heartbeat and other phenomena. Various other applications, where reactions due

to direct or alternating currents on the human body and its nerve system were studied, have provided interesting results. Some of these have furnished pertinent data valuable to our armed forces. Reactions of the nervous system to concussions and forms of noise have been recorded. Some of the data obtained permitted estimation of nerve endurance limits. In supersonic treatments of nerve disease cases, highlights of results were gathered by the oscilloscope.

Encephalography is only in its infant stage. Records of study are being compiled, new reactions noted, but the possibility of answering the unknown has been only scratched through the medium of the oscilloscope.

In conclusion the writer hopes that this gathering of applications of the oscilloscope will further its use and advance its ultimate design to still greater potentialities of utility. The best that is offered needs still greater powers of versatility to permit the scientist, engineer and technician to continue on the road of scientific progress. For those who have problems which can be translated into motion within the limits of the instrument, and wish to have a quick solution, the oscilloscope will provide it.

Ingenuity and imagination correctly applied will result in progress in the desired direction.

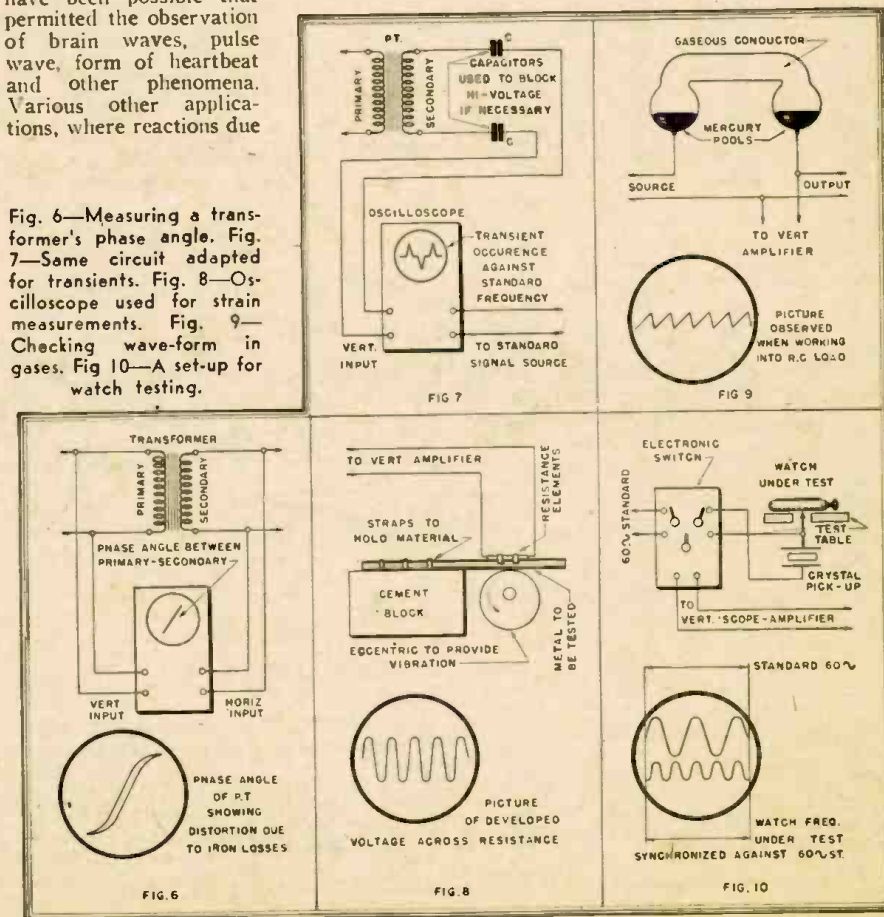

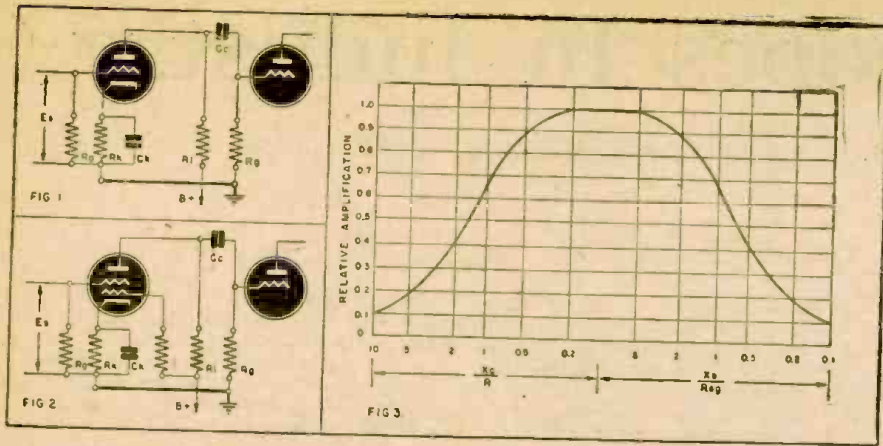

Figs. 1 and 2—Typical resistance-coupled stages using triode and pentode. Fig. 3—Response curve of such amplifier circuits.

Speech Amplifiers

Part II—Frequency Considerations

By ROBERT F. SCOTT

TO utilize the output of a vacuum tube amplifier, the plate of the tube in the output stage must be connected to the high voltage supply through some kind of plate load. This load may be inductive or resistive. Resistance coupling is the more commonly used and so it will be discussed first.

Resistance-capacitance coupling is employed with equal ease for triodes as well as pentodes. Figures 1 and 2 are actual circuit diagrams of single stages of resistance coupled amplification employing triode and pentode tubes respectively. It will be noticed that there is a resistor in the plate circuit of each tube. This is the plate resistor and is designated by the symbol, R_p . Also attached to the plate is a condenser which has its opposite end attached to the grid resistor and the grid of the following tube. This condenser is called the coupling condenser, C_c and serves to transfer the alternating impulses to the grid of the following stage. The voltage passed by the coupling condenser is impressed across the grid resistor, R_g . The voltage drop across the cathode resistor, R_k , serves to make the cathode positive with respect to the grid. (or the grid is negative with respect to the cathode). The cathode resistor is usually by-passed by a condenser, C_k , placed in the circuit to by-pass any alternating voltages around the cathode resistor. This is done so that the only drop in voltage across R_k will be due to the presence of direct current flowing through it.

One characteristic of resistance coupling is the way in which the gain of the stage varies with the frequency. It is a simple matter to place a resistance coupled network in a circuit between two stages and call it a resistance coupled stage. This stage will have certain gain and frequency-response characteristics which will differ from any stage having different values or tubes. The frequency response characteristics of such a stage are such that it will pass a broad band of frequencies but the amplification will fall off sharply at the lower and higher frequencies. The response curve of all resistance coupled amplifiers is the same and for this reason, the curve of the resistance coupled stage may be called the universal response curve for resistance coupled amplifiers. This curve is shown in Fig. 3.

GAIN VERSUS FREQUENCY

Figs. 4-a-b-c-d show the equivalent circuits for the resistance-coupled triode amplifier stage. Fig. 4-a shows that the grid input voltage, E_s , has the same effect upon the changes of plate current as a generator having an output voltage equal to μE_s placed in series with the plate resistance and the plate resistor. Two values of capacitance are seen in these figures which do not actually appear in the amplifier circuit. These capacitances, C_p and C_k , represent values which we cannot eliminate from the circuit. C_p is the sum of the capacitance that exists between the plate and grid of the tube plus the capacitance which exists between the wiring around the plate of the tube. C_k is the input capacitance, which is a combination of the effects of the grid-to-cathode capacitance

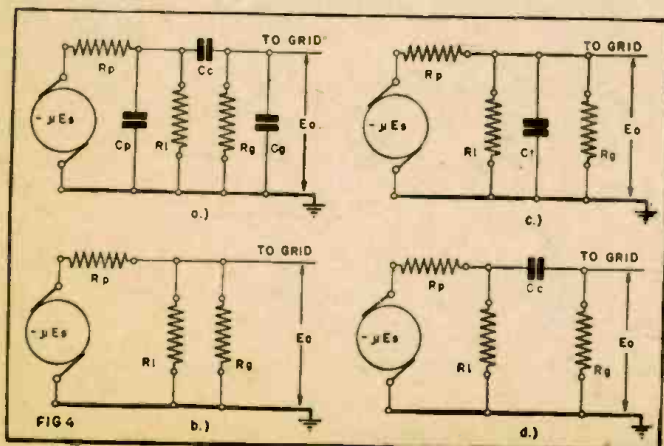

Fig. 4—Effect of frequency on response. At (a) is the equivalent circuit, (b) the effective circuit for intermediate frequencies, (c) on higher frequencies, and (d) is the effective low-frequency circuit.

and the grid-to-plate capacitance. In many cases, the circuit wiring at the grid of the following tube may be of such a value as to enter into the reactions of the stage.

As we have seen, the behavior of an amplifier varies with the frequency; therefore its behavior for each frequency range must be studied individually. The behavior of the stage at intermediate frequencies will be discussed first since all other calculations are made with respect to the gain at intermediate frequencies. For a bird's-eye view of the circuit as seen by the intermediate frequencies, look at Fig. 4-b. In this circuit, the coupling condenser has been replaced by an unbroken path. To understand the phenomenon of the missing condenser, let us recall what we know about the action of the condenser in the alternating current circuit.

A condenser does not pass all frequencies with equal ease but gives preference to higher frequencies. Coupling condensers for resistance coupled stages are so selected as to have very little reactance or opposition to the flow of alternating currents in the intermediate range.

EFFECT ON A TEST SIGNAL

Let us take a signal covering all of the audio range and having a voltage equal to E_s and place it upon the grid of our amplifier tube. The tube will amplify to a value μE_s . This is the value of the signal when it appears across the plate resistor, R_p . The middle or intermediate range will see a clear path over to the grid of the following stage. Therefore we may consider the grid resistors, R_g , to be in parallel with R_p . This will have the effect of reducing the resistance of both of these resistors. ("The law of parallel resistors.")

In this case, the resultant resistance of R_p and R_g in parallel act as the plate load of the tube. Since this resultant resistance is smaller than either one of these values regarded separately, the output voltage will be less than would appear across R_p if it were not coupled to the grid circuit of the following stage. For this reason, it is desirable to have the values of R_p and R_g as large as practical. The value of R_p cannot be increased beyond a specific value because of the direct current losses which would appear across it, making it necessary to employ unusually high values of plate-supply voltages. The resistance of R_g should be made as high as permissible.

The amplification in the intermediate range of frequencies is given by the following equation:

$$\text{Gain at intermediate frequencies} = \frac{E_o}{E_s} = \mu \frac{R_L}{R_L + R_p}$$

where μ = amplification factor of the tube

$$R_L = \frac{R_p \times R_g}{R_p + R_g}$$

= resistance formed by R_p and R_g in parallel.

It is perhaps unfortunate that the high and low frequencies cannot see a clear path, unhampered by the coupling condenser and the shunting capacitances, as is seen by the intermediate frequencies. For it would then be possible to have a resistance-coupled amplifier with a straight line frequency response curve.

AT HIGH FREQUENCIES

Fig. 4-c is similar to the path as seen by the intermediate frequencies, but we have a shunting capacitance C_p which appears

(Continued on page 114)

Silent Recording Methods

New Developments Will Reduce Noise on Both Disc and Film

By I. QUEEN

JUST prior to the war, sound recording for commercial and home use was rapidly increasing. Many of the larger radio receivers were being sold as combined radio-recorders and reproducers (disc) so that not only could a direct home recording be made, but incoming radio selections could be taken off the air and recorded for future playback. It is natural to wish to repeat the performance of a famous comedian, favorite orchestra or world leader, just as it is for us to photograph far-away places, scenic wonders, friends or important events. The recording of sound or picture enables us to bring forth at will events of the past.

It is confidently expected that the post-war period will bring widespread use of electronic equipment. This will be especially true of television, which is expected to follow within a few years of our conversion to peaceful endeavors. Just as the development of radio brought with it a wide interest in recording on disc, we may expect the advent of television to make us more sound-plus-picture conscious.

We may wish to record our favorite actress, football game or political leader. Possibly the television program may call for a particularly interesting experiment in chemistry, a "how to make it" stunt or the exhibit of a rare document. By means of a sound-on-film camera and recorder we may make a permanent record of the scene as it appears on the television screen and are then at liberty to repeat it for friends who may have missed it or to file it away for future reference.

SOUND RECORDING METHODS

The principles involved in recording sounds are not particularly complicated or different from those with which the radio technician is acquainted. Disc recording is the simpler of the two methods in common use, but film recording is not much more difficult to understand. Many articles have appeared in *Radio-Craft* magazine during the past few years on both subjects. The writer, for instance, covered "Sound on Film" in three parts beginning November, 1937, and "Sound on Disc" in the March, 1941, issue. The former method is used where an accompanying moving picture exists, while the latter is the simpler and less expensive of the two.

The technician and serviceman may well consider recording and reproducing of sound as an extension of radio. He should accordingly be prepared to handle work in these lines. Judging by requests for articles on sound recording it is apparent that high interest exists among *Radio-Craft* readers. Accordingly, this article will describe several new developments pertaining to this field.

SOUND ON FILM

Sound on film utilizes the principle of a narrow light-sensitive track which travels uniformly before a varying light source. Fig. 1-a shows a piece of variable density recording wherein the beam of light extends through the entire width of the track

and is varied in intensity either by a mechanical valve or a varying light source. Fig. 1-b is a variable-area recording wherein the light source is constant, but the film area exposed is changed. These changes correspond to changes of acoustic energy at

the microphone. During the recording the film is everywhere masked off except for the small slit on which exposure is desired. For reproduction the film travels uniformly in front of a similar slit. A constant light (Continued on following page)

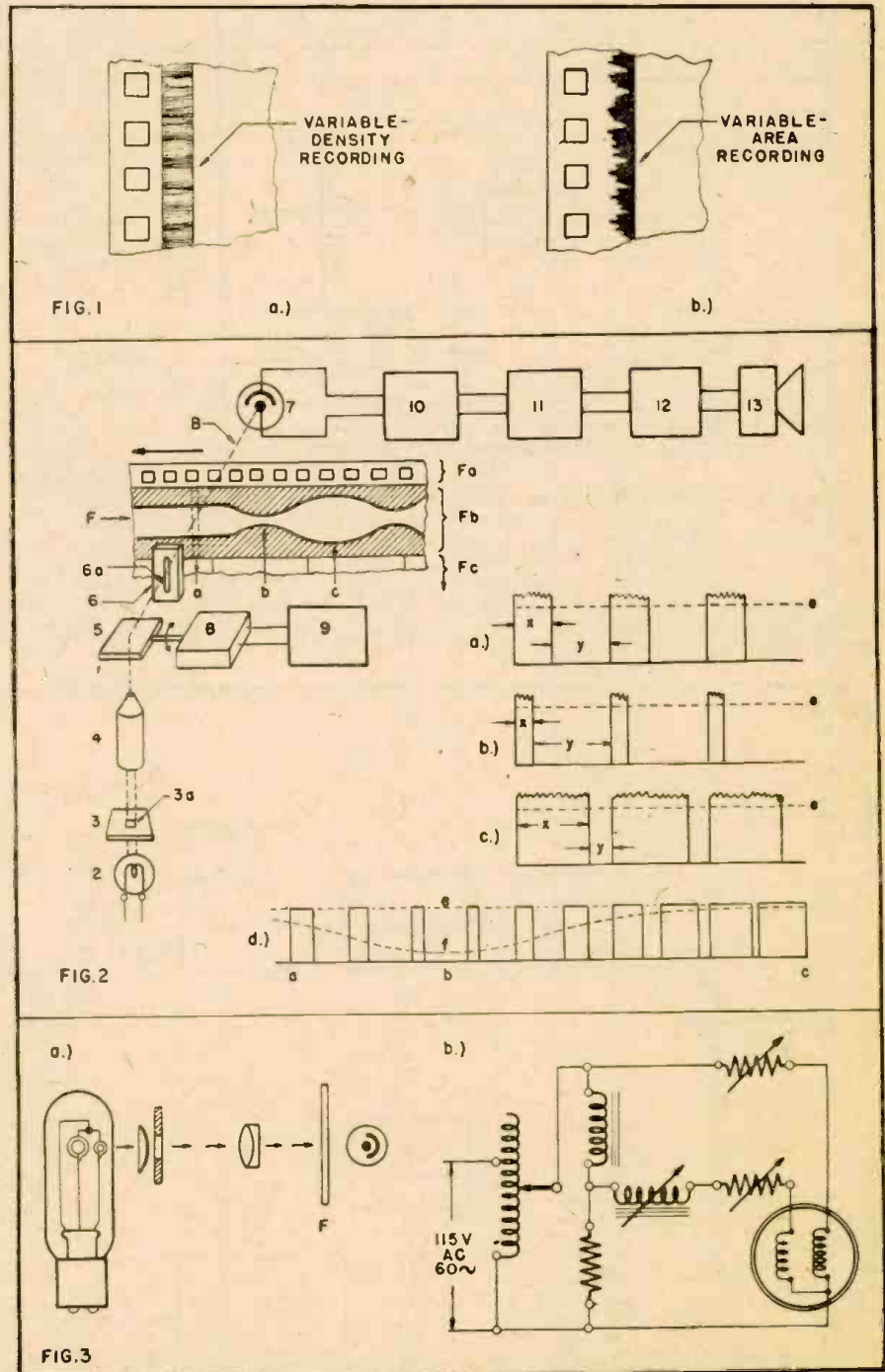

Fig. 1—The two common types of sound-on-film. Fig. 2—An improved system of noiseless sound-on-film reproduction. Fig. 3—A special circuit for eliminating the exciter-lamp hum.

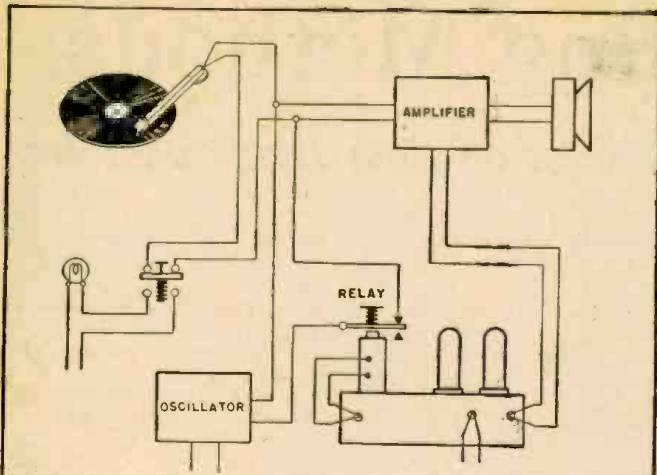

FIG. 4

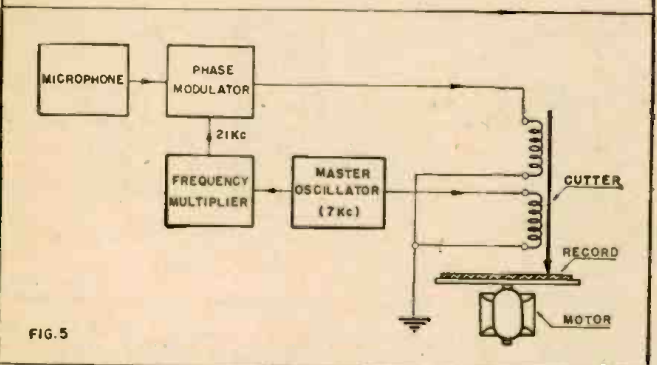

FIG. 5

Fig. 4—A synchronizing system for use with non-continuous matter such as lantern slides. Fig. 5—Phase-modulation with disc records.

source shines through this slit onto a photoelectric cell so that the modulated beam results in corresponding electrical vibrations. For less noisy reproduction it is desired that at low modulation levels the area of the slit be reduced so that the grains of the film will cause less noise. Therefore a masking device (in the variable-area method)

light intensity (vertical) against time (horizontal). The time interval shown as *x* is that in which the beam travels along the transparent part, *y* corresponding to the opaque part. Note that the intensity during *x* is not constant. This is due to film grain, dust and other imperfections, which will result in noise.

follows the envelope of the sound so that the exposed area is only that necessary for sound reproduction.

A very recent invention by a Maine man, John R. Cooney, will result in the complete elimination of noise due to film grain, etc. Fig. 2 shows a constant light source, 2, passing through an aperture, 3, and an optical system, 4. A vibrating mirror, 5, is connected to a piezo crystal unit, 8, which is actuated by a 25 Kc. oscillator, 9. The beam after passing through the masking plate, 6, is approximately .001" square and scans from one side of the sound track to the other on the film, on to a photocell, 7. An amplifier, 10, feeds into the limiter, 11, and detector, 12, and then into the loud-speaker, 13.

As a result of the 25 Kc. vibration of the mirror, the scanning beam will travel back and forth across the track. Referring to Fig. 2a, we plot

Fig. 2b shows what happens when the film has moved so that section b is now in front of the beam. Evidently, the opaque sections are now greater than the transparent. Fig. 2c corresponds to film portion c. We therefore have pulses of light which the photocell sees as almost constant, but are really modulated by feeble changes in amplitude.

The limiter, 11, is set to a pre-determined level to slice off these irregularities as in Fig. 2d, resulting in noise-free reproduction from the speaker.

Another recent improvement in sound reproduction is shown in Fig. 3. One source of difficulty has always been in connection with the exciter bulb. This requires a heavy current for intense illumination, and an A.C. source provides a loud hum in reproduction. One solution has been to use a source of super-sonic power; which, however, results in a complex arrangement. In the present case we make use of a bulb containing two filaments, a thin one and a massive one.

As illustrated, a 60-cycle source connects to an auto transformer, the output going to the heavy filament (at the right in Fig. 3a). Due to a phase-changing arrangement consisting of choke and resistor, the lighter filament is supplied with a voltage 90° out of phase. The maximum brilliancy of one filament is reached at the instant when minimum brilliancy of the other is attained. With both filaments focussed for the same spot, one overlaps the other, resulting in a minimum of hum. This new type of bulb is due to Robert L. Haynes of Indianapolis.

SOUND-ON-DISC

The utility of disc recording is limited to cases where synchronized moving pictures are not desired. However, this method is well adapted to accompany non-synchronized pictures or single frame pictures. For instance, until the start of the war, great interest was shown by the public in the single-frame cameras exemplified by the Leica. This type takes only one still picture at a time, and because of the compact-

(Continued on page 121)

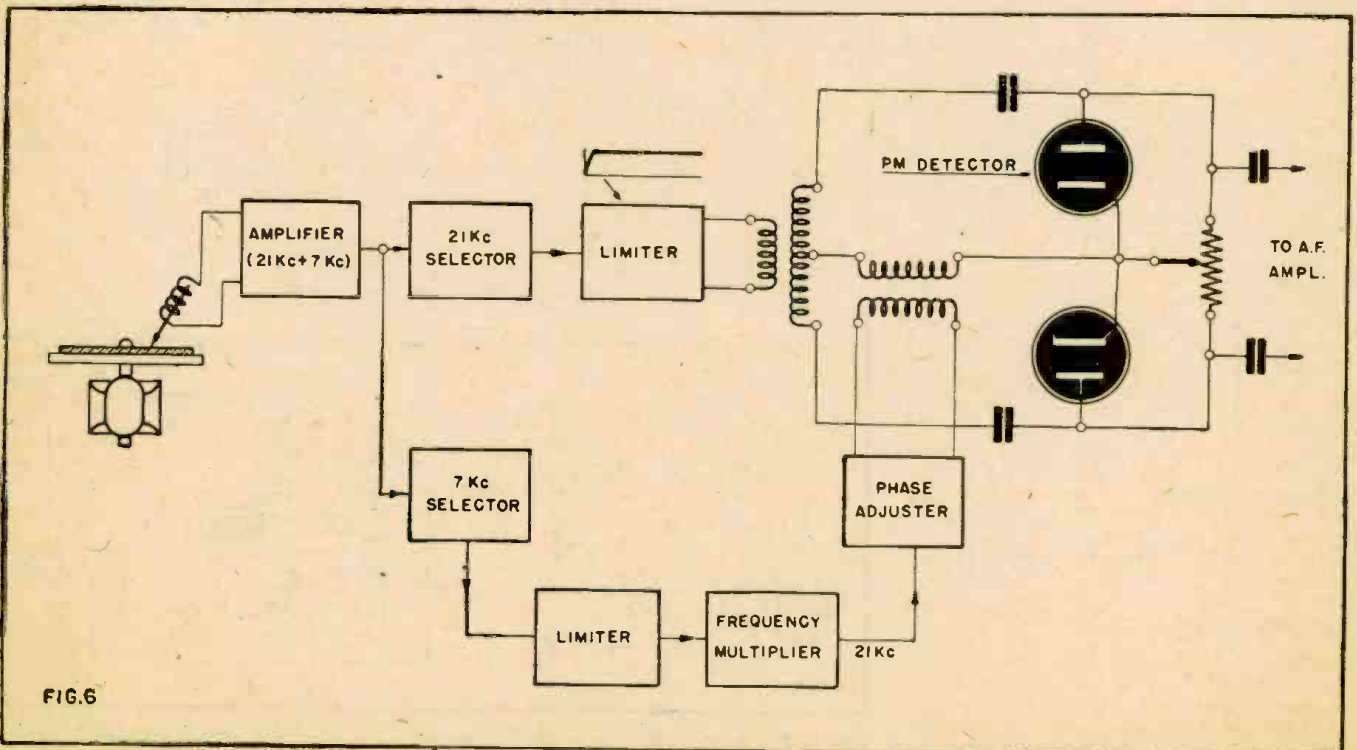

FIG. 6

Fig. 6—Playback arrangement for phase-modulated records. Limiters and discriminators cut off noise, give high-quality reproduction.

BROADCAST EQUIPMENT

PART III MASTER CONTROL-ROOM FACILITIES

By DON C. HOEFLER

THE transmitting equipment of a modern broadcasting station is usually located in the suburbs of the city which it serves, to obtain better coverage. The absence of tall buildings and other metallic structures which would otherwise reflect and absorb the emitted R.F. energy, allows for a greater primary service area.

The FCC requires that the station's main studios must be located within the city proper. This imposes no hardship, for it is the most practical arrangement from the standpoint of accessibility to the staff, artists, and sponsors. It does, however, require a central point for the superintendence of all incoming and outgoing audio signals, before reaching the transmitter. Such a spot is located adjacent to the studios and is known as the Master Control Room. It is here that all incoming programs from the adjoining studios, remote lines, network lines, or radio receivers are received, amplified to their proper level, and fed to the transmitter program line. The equipment used is often identical or very similar to that previously described for the studio control booth.

THE LINE AMPLIFIER

The line amplifier is of the same type as the studio amplifiers, but its function is to bring the amplitude of the program up to the level required to feed the program line, which is usually 0 db. Naturally, the same careful designing to minimize noise and distortion must be observed throughout the speech equipment. To prevent the picking up of stray electrostatic and electromagnetic fields by the equipment wiring and program lines, they must be thoroughly shielded. All plugs, sockets, and other connections, must be so made as to guarantee firm contact, as the most inconsiderable variations in contact resistance will produce seriously objectionable noises in the output.

Thermal-agitation noise is due to the random motion of electrons within a conductor. This effect is made worse by the fact that it increases directly as the bandwidth of the amplifier, as such noises usually contain practically every frequency within the audible spectrum. Fortunately, thermal agitation noise decreases very rapidly as the input resistance of the amplifier is lowered, and thus may be partially offset in this way. Shot effect results from the fact that the electron stream from cathode to plate is composed of a series of particles rather than an absolutely uniform flow. The electrons arrive at the plate with some irregularity, to form a noise component in the plate current. However, the presence of an adequate space charge in the tube tends to smooth out these irregularities to such an extent as to practically eliminate shot effect when complete temperature saturation exists. This is sometimes accomplished by operating the filament voltage of the input tube, which is

This typical control room is at Radio Station WLS, Chicago.

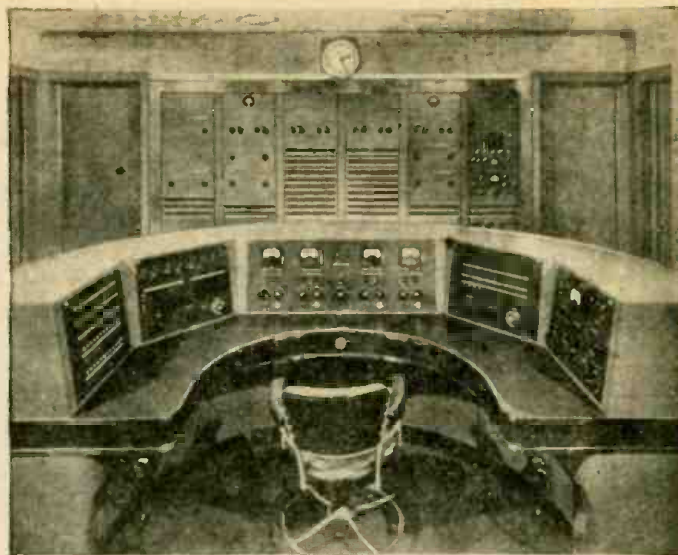

Courtesy Radio Corporation of America

the most important in this respect, above its rated value, thus insuring a plentiful electron supply and a more uniform plate current.

Carbon resistors are another source of similar noise, and should never be used at points carrying a low program level. Such noises increase rapidly with the value of the resistance. The amplifier tubes must be extremely quiet in operation, are usually of the non-microphonic type, and cushion-mounted. If a monitoring loud-speaker is operated nearby, it often becomes necessary to surround the first tubes with a blanket of cotton batting, in order to insulate them from acoustic feedback.

Tube sockets are very important, for if firm contact is not made at all times, or if there is a great tendency toward oxidation, more troublesome noises may be introduced. The sockets and grid cap contacts should be cleaned with carbon tetrachloride or crocus cloth at least once every three months to insure noiseless operation. Whenever possible, the input transformer is center-tapped to ground, and is always very heavily shielded. The amplifier is mounted as far away from all A.C. fields as possible, and the associated transformers and chokes should be rotated to the angle of minimum coupling. The power supply must be completely filtered, and decoupling filters must prevent undesirable feedback between stages.

The amplifier circuit itself must be so designed that it reproduces faithfully, without noticeable change or distortion of any kind, the program material produced in the studios or reproduced from transcriptions. In broadcasting's earliest days, speech amplifiers were nearly all impedance-

coupled. Then as the quality of transformers was improved, transformer coupling attained widespread usage. With the fairly recent advances in high-gain tubes, present amplifiers are mainly resistance-coupled, with input and output transformers for impedance matching. All modern speech equipment is designed to have a substantially uniform response from 20 to 15,000 c.p.s. or better.

VOLUME CONTROLS

Since the primary service area of a transmitting station depends, among other things, upon the average degree of modulation, it is advisable to keep this as high as possible. Also, to avoid serious crosstalk and excessive background noise, the normal program line level should be limited to 0 db, with a maximum of +2 db on peaks. As the volume range of even the best program transmission circuits presently in general use is limited to 25 or 30 db, and since the dynamic range of a symphony orchestra, for example, is about 60 db, it is evident that some volume compression is necessary.

The master control-room engineer has final control over all program material before it is impressed upon the program line to the transmitter, and it is his duty to insure that the volume is at the proper level and within the specified ranges at all times. Since at best, this system restricts the fidelity of sound reproduction, because it purposely introduces amplitude distortion, it is obvious that an incompetent control-room operator can easily ruin an otherwise perfect program.

Ladder-type attenuators are most often
(Continued on page 108)

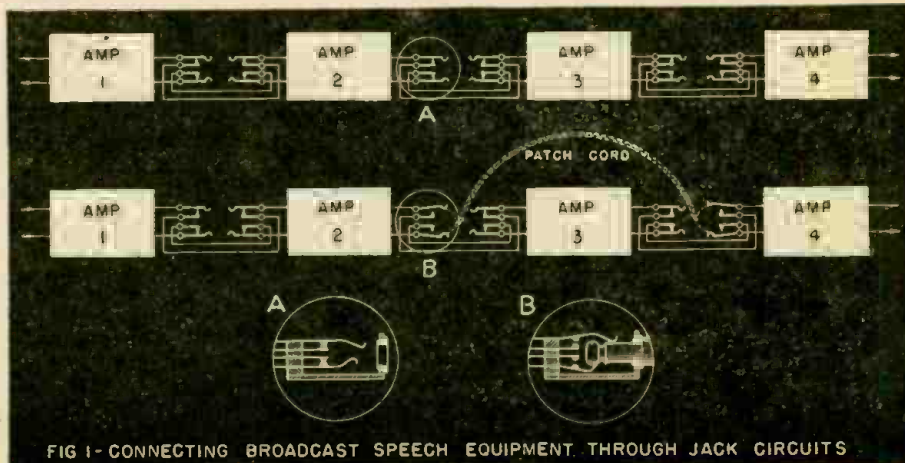

FIG 1 - CONNECTING BROADCAST SPEECH EQUIPMENT THROUGH JACK CIRCUITS

ECONOMY 20-WATTER

An Amplifier Which Combines High-Fidelity and Simplicity

THIS amplifier was originally designed and built a couple of years ago, partly to maintain the writer's reputation and show up some of the very inferior jobs used in dance-bands, etc., and partly to see how much power could be got from how small an amplifier. Incidentally some 6B5 and 6N6G tubes are bulkier than others.

The 20-watt amplifier features such refinements as inverse feedback, low hum level, few tubes (only five altogether), low noise level, extended frequency range, etc., but there is nothing very unorthodox in the appearance of the circuit. Rather, the high output power with an economical power pack is obtained by the correct choice of tubes and circuit constants. Low noise level and low hum level are obtained in part by the small number of tubes and by having all controls placed *after* the first tube.

CHOICE OF TUBES

The tube line-up is: 6SC7 as first voltage amplifier for both crystal microphone and needle-armature hi-fi pick-up, 6SC7 as driver and phase inverter, a pair of 6N6G's in class AB₁ and a 5V4G rectifier.

*Proprietor Straede Electronic Laboratory; Lecturer in Electronics, Melbourne Technical College (Australia).

By JOHN W. STRAEDE*

tive tubes are a pair of 79's followed by a pair of 6B5's with an 83V as rectifier. For those tubes the circuit constants need not be changed as shown in the schematic diagram. For the output stage, a pair of 6L6G's can be used in class AB₁ with the load reduced from 10,000 ohms to 9000 and the bias resistor increased to 325 ohms. In addition, a 300 ohm resistor of 5 watt rating must be connected in series in the H.T. supply. However, the 6N6G or 6B5 tubes should be used if possible as these give superior tonal quality besides being very noncritical as regards load impedance (a 100% rise in load impedance causes less than 5% rise in power output).

The power supply is very economical indeed, as the transformer has a rating of only 100 Ma. This is quite enough as the total no-signal drain is only 92 Ma. for the whole amplifier and the average drains on speech and music are only 95 and 98 Ma. respectively, although peak drains of about 110 Ma. may be encountered for periods of about a tenth of a second.

Some rather anomalous prices for tubes

exist in Australia. For example, the octal-based 6N6G costs more than its UX-based equivalent, the 6B5. On the other hand, the 83V costs more than its octal equivalent, the 5V4G. Many tube types are now non-existent in Australia, although we do turn out some types not very common in America, e.g., the EL3NG, the 1M5G and the 6B7S. However, we manage fairly well and the number of types made here is increasing.

PHASE INVERTER

The phase inverter uses the floating para-phase system, this giving an automatic near-balance, the "second" output tube receiving slightly less drive than the first. Inverse feedback is applied from the primary of the output transformer to the anode of the driver (first section of the second 6SC7). This feedback gives a reduction in distortion, a reduction in hum and also a reduction in the unbalance of the output tubes. The reduction in unbalance occurs in two ways—first the general negative feedback action reducing the drive more in one direction than the other, secondly the bias resistor of the phase inverter is not by-passed so that the first section (working at a higher level than the other, because of the

(Continued on page 118)

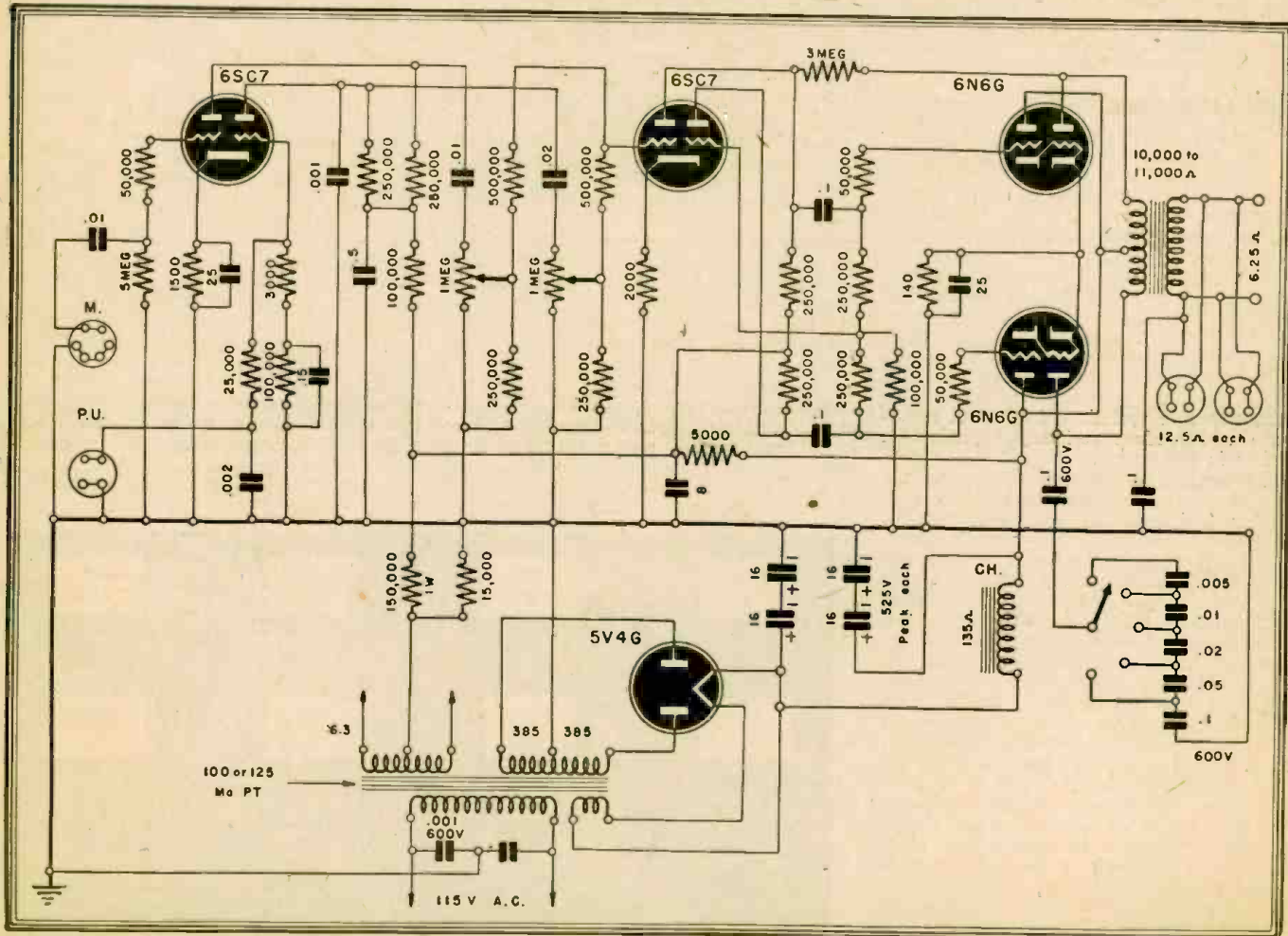

Schematic of the Economy 20-Watter. Due to the use of 6N6-G tubes, plenty of gain and power are obtainable from a 5-tube circuit.

Record Changers

How They Work and How to Service Them

By JOHN NEEDRE

CAUSE of many a headache in the modern service shop is the automatic record changer, which has become prominent due to the tremendous increase in popularity of phonograph records. To the serviceman in the early stages of attempting to acquire efficiency in radio service work, these intricate mechanisms are great time wasters. The first time he watches the mechanism of an automatic changer he can observe directly the gears and levers during their complete operation and still remain baffled as to how it works. Even after he has learned the purpose of all the levers he finds that trouble may become apparent at one point and have its source at another point in a gear seemingly unrelated to the trouble. All the while, precious time in which dozens of other paying jobs might be accomplished, is wasting away.

A little previous knowledge is indispensable in speeding up progress on any job, so let us see how record changers can be broken down into simplified components that will make them easily understandable. Then it will be possible to point out typical troubles and remedies which will give us a head start on the job.

There are a few types in which the records are stacked on the turntable and each one flipped off, as it finishes playing, into a container at the side. In either case, the pickup arm must rise and move aside when the record has finished playing and return to the correct place on outer edge of the record that has just come into place.

In order to provide the required motions of the record release and pickup arm, a cam wheel is used in practically all types. This may be the "high and low" type cam or it may have a groove impressed in it. See Fig. 1. A is the horizontal movement for activating the record selector, B shows the vertical movement which raises or lowers the pickup, and C the horizontal movement which swings the pickup on or off the record. It is common practice to locate this cam so that one side is near the swivel of the pickup arm. In this location it can easily control the up and down (vertical) motion of the pickup.

The same cam will provide the lateral motions for moving the pickup arm back and forth at the proper moment to place it on the record or remove it when the record has finished playing. See Fig. 2. A. The cam wheel has pushed back the lever which is fixed to the same shaft as the pickup arm, thereby swinging the pickup away from the turntable.

B. As the cam continues to rotate, it allows the arm to move toward the record, stopping at a predetermined point called the "needle landing place" which should be

(Continued on page 110)

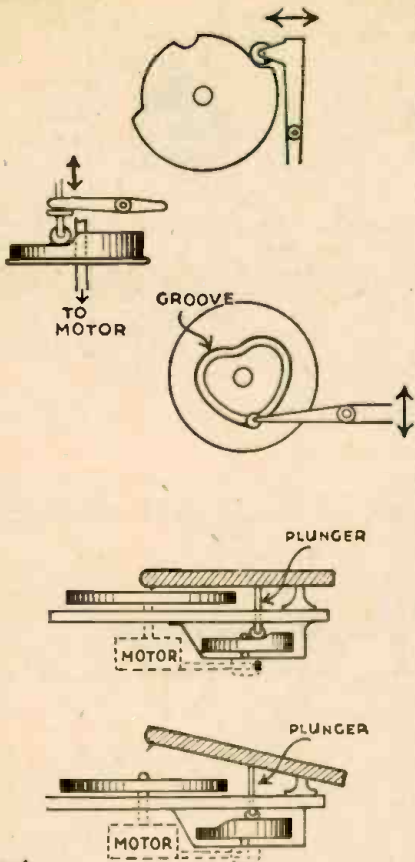

Fig. 1

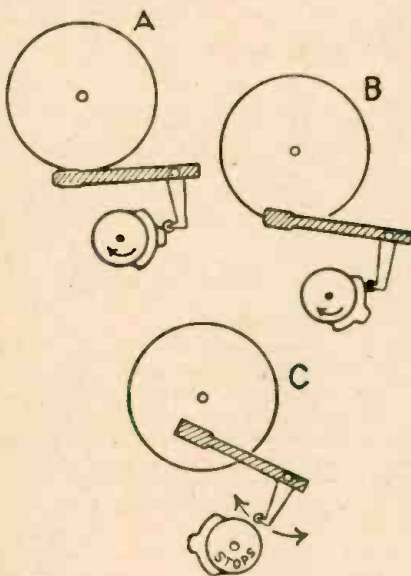

Fig. 2

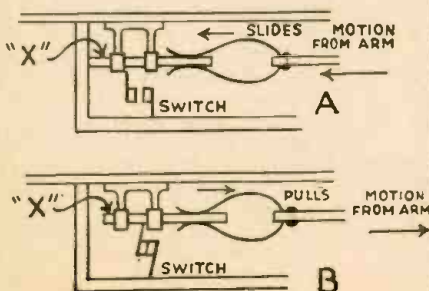

Fig. 3

RECORD CHANGER SEQUENCES

In almost every record changer of the types in use today the records are stacked one on the other and supported directly above the turntable so that they may be released one at a time and fall in place to be played. Gravity and atmospheric pressure connive in conveying the record to the turn-

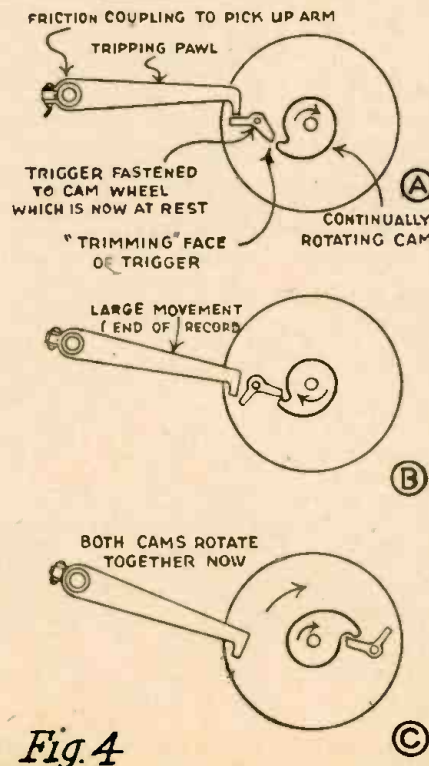

Fig. 4

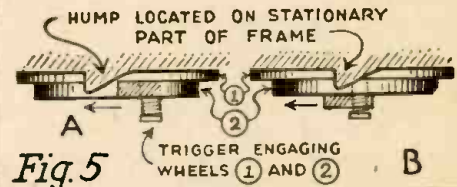

Fig. 5

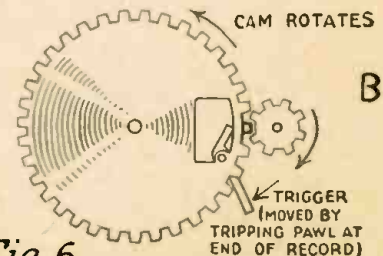
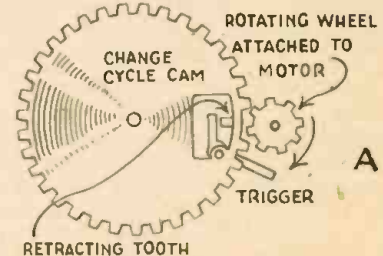

Fig. 6

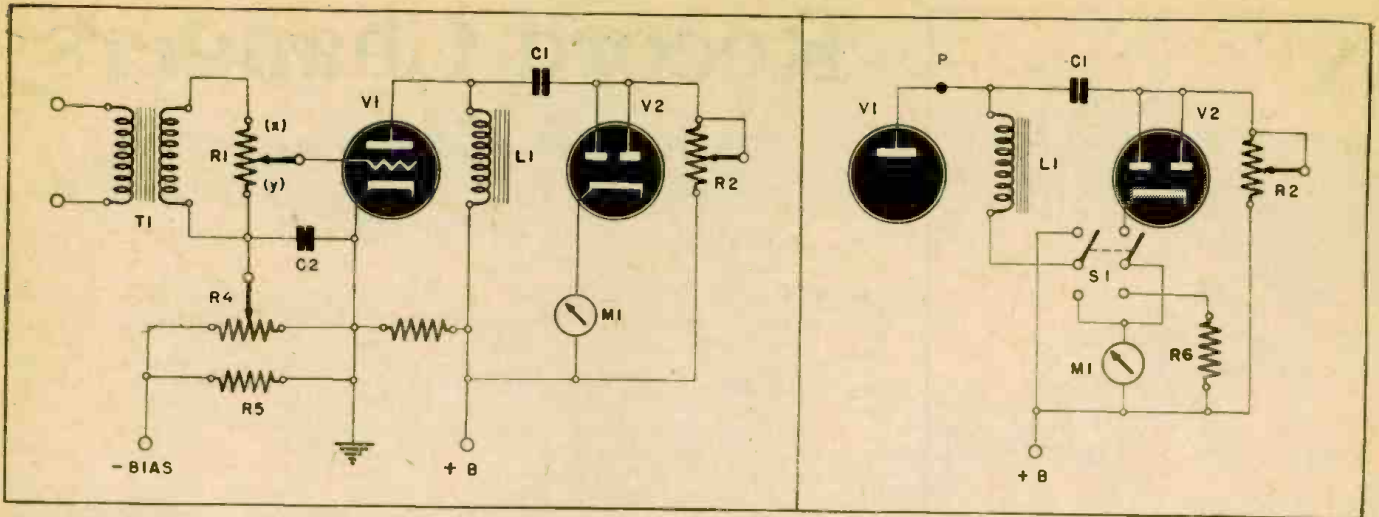

Fig. 1—The basic circuit of a simple transconductance tube tester. Fig. 2—How the checker can be modified for making emission tests.

Dynamic Tube Tester

This Instrument Measures Transconductance Values

By JOHN A. DEWAR

WITH few exceptions, all the tube testers on the market today are the total emission type. All elements but the cathode are tied together and the emission of the cathode is measured by a D.C. milliammeter. Such testers require few parts and are useful for short and emission tests of rectifiers and output tubes, where the emitting ability of the cathode is one of the major factors. In other types of tubes they have severe limitations, for they give no indication of the tubes' transconductance, abbreviated S_m . (Mutual conductance, abbreviated G_m , means the same.)

Transconductance by formula is:

$$S_m = \frac{dI_p}{dE_g} = \frac{\text{change in plate current}}{\text{for given change in grid voltage}}$$

Thus, if an A.C. signal of 1 volt is impressed between grid and cathode of a tube with normal plate and bias voltages and its A.C. plate component measured in microamperes, the result is a direct reading in micromhos (μMhos). If the A.C. output is 1 MA:

$$S_m = \frac{dI_p}{dE_g} = \frac{.001}{1} = 1000 \mu\text{Mhos}$$

Since the tube's S_m is directly affected by emission, plate resistance, positioning of elements, etc., and the test is made under conditions closely approximating actual working conditions. This type of test is greatly superior to straight emission tests. It has even been found in life tests on a number of tetrodes* that while emission fell off with some tubes to a point where they might have been rejected by an emission tester, their S_m had actually increased and they were more efficient amplifiers than when first tested.

Figure 1 shows the basic circuit for such a tester. Theoretically the output measuring device should be an A.C. milliammeter of the dynamometer type which responds only to A.C. However, since such instruments

are scarce, it has been replaced with a choke L1 to apply the plate voltage, an isolating capacitor C1, a diode rectifier and D.C. milliammeter M1. It will be noted that the output impedance of the circuit comprised of L1, C1, V2, M1 and R2 is quite low. Therein does the S_m test differ from actual operating conditions, for the purpose is to measure the A.C. output into a load small compared to the tube's plate resistance.

THE REQUIRED EQUIPMENT

Since, due to war shortages, odd parts are to be used, no specific values are given. T1 supplies the 60-cycle A.C. signal for the control grid and can be any step-down transformer, a winding on the power transformer, filament, bell-ringing or even an output transformer, since no current is drawn from it. R1 is to adjust the voltage applied to the grid and can be any value of volume control. It can be set at one volt, or if the meter hasn't sufficient flexibility, it can be put on the panel and set for various Mho scales. This would also be a simpler procedure than switching shunts across the meter for lower range meters. L1 can be a filter choke, audio choke or the primary of an output transformer. It should have low resistance so too great a D.C. drop will not be created across it when testing power tubes. It should have fairly high impedance at 60 cycles—say at least 30 H. C1 and C2 should be paper capacitors offering low impedance at 60 cycles—2 Mfd, preferably larger.

The meter can be any D.C. milliammeter with a fundamental range of from 1-6 MA, though a higher range could be used if the fixed grid input voltage of one volt was increased. Lower range meters can have their scales extended with suitable shunts. Since tubes vary in S_m from a few hundred to about 6000 micromhos, the scale or scales will have to be readable from approximately 0.2 to 6 Ma. V2 can be a diode such as 6H6 or 84. Any tube with good cathode emission can have its grids and plate tied together to operate as a diode, and will

work here. R2 can be any potentiometer that will carry the meter current. It forms the diode load and is adjusted for maximum meter reading with a given input signal. Once adjusted it can be left set or replaced with a fixed resistor. R4 is the potentiometer (any volume control) for giving the tube its required bias. It must be much larger in value than R5 so that it will not pass too much current due to the drop across R5. It will be a front panel control and will be calibrated. Its setting determined by meter measurement, and listed for each tube.

The rest of the instrument requires: 1—A tapped filament transformer T2, to supply all tube requirements between 1.1 and 117 v. 2—A source of B supply of about 350 v. with good regulation and bleeder tapped about every 50 v. to supply various plate and screen potentials and bias. 3—An array of sockets to accommodate all types of receiver tubes in use, wired together according to standard pin numbering, with each of the nine possible contacts brought out to pin jacks or terminals on the panel. The sockets, transformer, meter and filament switch of an old emission tester could be adapted to the purpose.

PATCH-CORD SYSTEM

This is essentially a technician's instrument and switching arrangements would be complicated and costly. Therefore, with the exception of the filament, no switching arrangement was considered. Instead pin jacks and pin tip leads are used to make the various connections externally. This gives the instrument complete flexibility and freedom from obsolescence unless new type sockets are brought out, at which time they could easily be added.

Referring to Figure 3, it will be seen that the instrument must be used with a tube manual for the application of proper voltages to the correct pins and to find the S_m to be expected under these conditions—unless the builder prefers to make a complete list of pin numbers, voltages and S_m .

*Electronics Eng. Manual, Vol. I.

to be expected. The writer found it simpler to enter the bias setting and S_m in the tube manual.

Calibration of new scales for the S_m meter is carried out with known good tubes. The procedure will vary with the type of D.C. milliammeter used. Let us assume that it is a 0-6 Ma. This should give us a range up to 6000 μ Mhos. First we must set R_1 to apply one volt peak between cathode and grid. This should be measured with a V.T.V.M. if resistance of R_1 is high. If one is not available calculate it from the output of T_1 and the resistance ratio of R_1 :

$$E_g = \frac{x + y}{E_{ty}}$$

when E_g is signal output, E_{ty} is transformer output and equals 1.414 times voltage measured on ordinary meter; x and y are values in ohms either side of tap.

Insert a known good tube, say a 6C5, and apply voltages for an S_m of 2000 μ Mhos. If the output circuit were completely efficient a reading of about 2 Ma. should be obtained. In any case, mark the scale for 2000 μ Mhos. Similarly, repeat with say a 6J5 for 3000 μ Mhos, a 27 for 1000, a 6V6 for 4000, and so on. By consulting the tube manual, tubes with other values can be chosen and different tubes with the same S_m used for a double-check of the calibration, which should be fairly linear.

Some constructors may prefer to put R_1 on the front panel and log an arbitrary value for each tube which will give it the correct S_m reading to correspond to the manual data for given conditions. It should also be mentioned that the bias control R_4 can be used to vary the output reading.

If a 1 or 2 Ma. meter is used it would be best to have two or even three scales, increasing the meter's range with a switch and shunts. In the case of a heavy current meter of 10 Ma. or more it would be advisable to increase the input signal voltage to give full scale deflection for a 6000 μ Mho reading. An S_m scale of 0-3000 will handle the great majority of tubes; in fact all but about twenty. A 0-6000 μ Mho scale will take care of all but nine, such as the 25L6 and 6Y6. The 1633 is highest with an S_m of 10,000. The builder can decide whether or not it is justifiable to extend the ranges in order to measure these tubes at their full rated value.

CONSTANT VOLTAGE NEEDED

It is of course essential to hold all voltages constant, hence, rheostat R_7 , capable of dissipating 30 to 40 watts. If an A.C. voltmeter is not available to incorporate in the instrument, pin jacks can be provided to use an external one. Similarly, with the meter M_1 which, if it belongs to a multimeter, could not be calibrated directly. It would then be necessary to make a conversion chart for it.

Also note that it is necessary to use a center tapped resistor when checking filament type tubes or a 60-cycle voltage will be impressed on the grid (independent of T_1), due to unbalance in the filament circuit. If the C.T. resistor is low in value it will have to be opened up by switch S_2 for high filament voltage tubes, or it will burn out. If a high value is chosen to avoid this it will bias the tube.

No provision was made for emission or short tests since it would further complicate the circuit and it is assumed that a conventional emission tester is available for such tests. However, the output circuit could be modified as shown in Figure 2 to provide emission tests by throwing S_1 . The switch is double-pole double-throw type. When used for emission tests the meter shunt R_6 is connected across the meter to give it a suitable range and the meter is

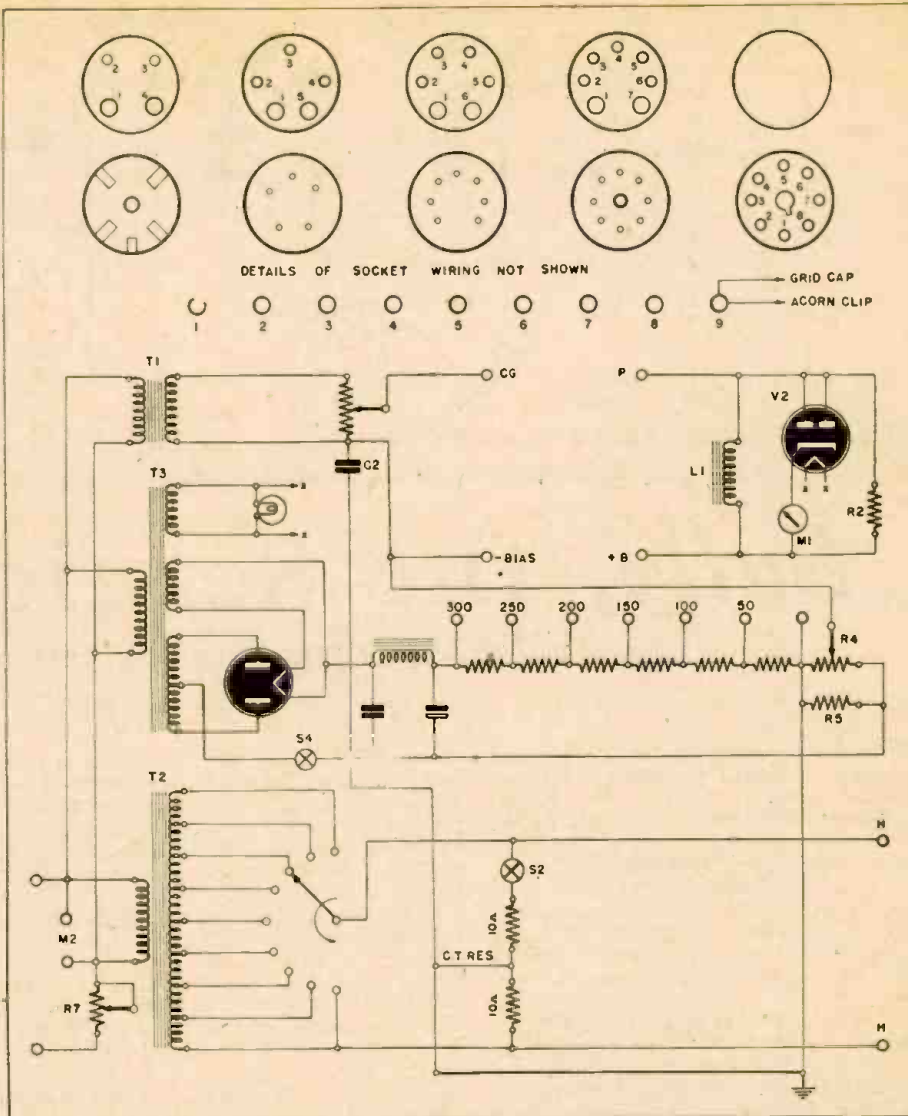

Fig. 3—A complete schematic of the checker. Tube socket terminals are connected in parallel and connected to the numbered posts just below. The actual wiring has been omitted for greater clarity. Connections are made to the voltage posts with the help of a tube manual.

inserted in series with the plate supply. Emission readings should correspond with manual data for given voltages. The meter should cover from a few mills to at least 60, and it may be desired to add another shunt and switch to give more easily read ranges.

To save pin jacks the writer used an insulated panel (Masonite) and drilled holes to take the pin tips, riveting springs to the back of the panel. Pin tips were made from heavy copper wire, insulated with tape. Since the operator may come in contact with 350 volts, it is advisable to break the plate supply with a switch, S_4 , while setting up for a test. Also, of course, care must be taken in making correct connections, or the tube might be damaged. Dual purpose tubes will require two or more separate tests.

If a tapped filament transformer is not available it can be wound on any power transformer with a good 110 v. primary. (When removing the old windings observe the number of turns per volt. If a 5 v. winding has 30 turns the transformer has 6 turns per volt. This can be used to compute where to tap off leads. In this case the 1.4 v. tap will be at $6 \times 1.4 = 8.4$ turns and 6.3 v. at $6 \times 6.3 = 37.8$ turns approximately.)

The dynamic tester is a most useful instrument and will well repay the builder in time saved, particularly when a replacement tube is not readily available for a substitu-

tion check, or a receiver for a check under operating conditions. At the same time it will save the rejection of low emission but otherwise good tubes.

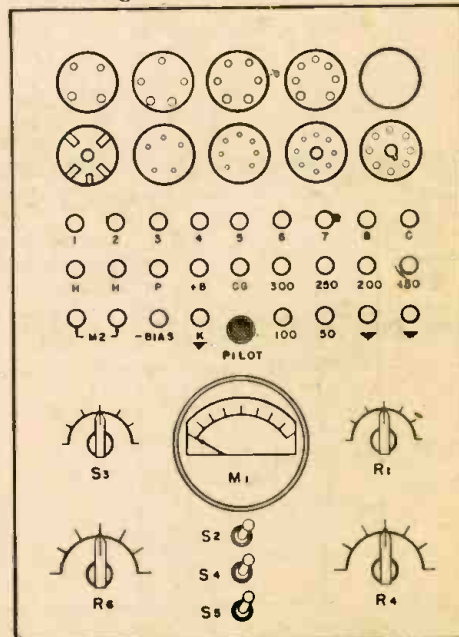

Panel layout of the transconductance meter is such as to promote speed and efficiency.

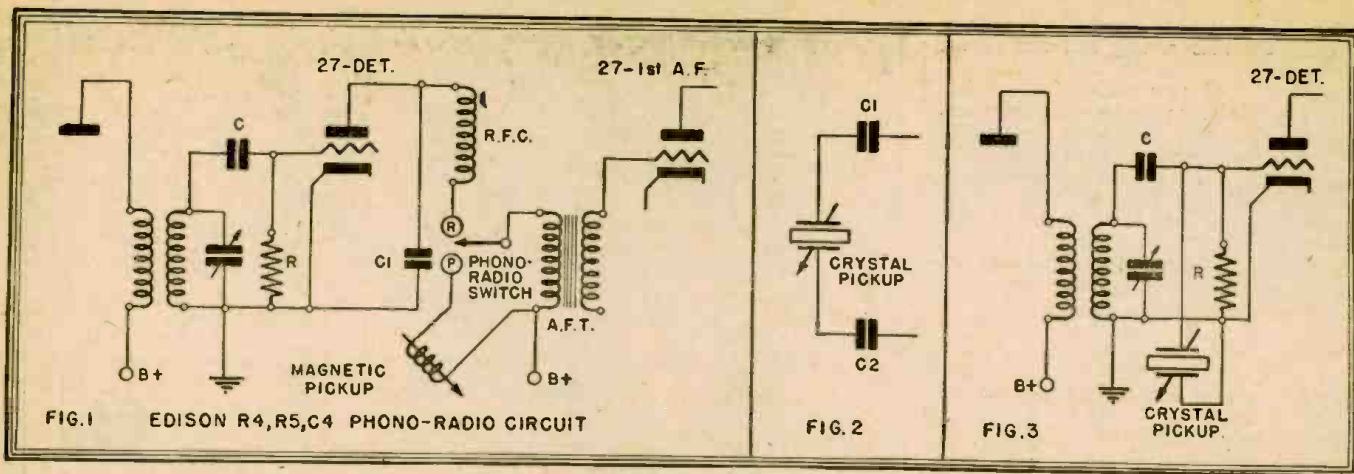

Sally, the Service Maid

Part III—THE CASE OF THE CRYSTAL PICKUP

By NATE SILVERMAN

It was Sunday morning, July 2, 1944, and Mrs. Cartwright's gardener and liveried chauffeur were removing the Edison radio combination from the back of the Rolls-Royce parked in front of the *Sally Mason, Service Maid* radio shop.

"You did a splendid job, my dear," said Mrs. Cartwright to Sally Mason. "The radio and phonograph both played better than ever before, after you overhauled them. But now, after only one month, I can hardly hear the phonograph records. The radio stations come in as loud and clear as they ever did. But all I hear when I play a record is a faint scratching sound."

"I shall do my best, Mrs. Cartwright," said Sally. No use antagonizing her best customer. And Mrs. Cartwright's daughter, a WAC, was bringing some of the girls home for July Fourth. And her son was bringing home some of his army friends.

"You can have the Edison ready, my dear?" said Mrs. Cartwright. "I know it's Sunday. I intensely dislike having you work on Sunday." Mrs. Cartwright smiled. "Double-time on Sundays, isn't it, my dear? I shall be only too happy to pay."

The Edison was now in the shop; the Rolls-Royce and its occupants were gone. Although Sally had felt anything but confident of her ability to replace the magnetic

pickup with the crystal pickup which she had sold Mrs. Cartwright, her manner was confidence itself. She'd handled crystal pickups before. What was so difficult about installing a crystal pickup? Particularly in a radio as ancient as that Edison. Nothing to it.

Yesterday, Technical Corporal Dan Bryner, home on leave for the holiday, had dropped in the shop for a few minutes. When she had told him about the Edison and he had offered to help, she had told him to enjoy his visit with his family and friends. She could handle this job. Why deprive him of his fun? Why make the poor boy work on Sunday, just as she was doing today? Oh, well.

She removed the magnetic pickup and checked for continuity. Just as she'd figured when she had played the phonograph in Mrs. Cartwright's home, the pickup was open. Probably burned out. Maybe a lead was broken. But why waste time? She'd already sold Mrs. Cartwright a new crystal pickup. Sally hoped there would be the noticeable improvement in tone quality she'd promised. Crystal pickups were superior to magnetic pickups, so Sally had no doubt Mrs. Cartwright would readily notice the improvement in quality. Maybe even in volume, too.

Sally removed the chassis from the cabinet and put it on one of her workbenches. Then she went to her desk and took out the envelope marked "EDISON R4, R5, C4." She and the Technical Corporal had made those diagrams.

Studying FIG. 1, Sally suddenly had an idea. True, the magnetic pickup, connected across the audio transformer primary, carried high voltage. Crystal pickups could not stand that voltage. Sally drew FIG. 2. There! Condensers C1 and C2 would prevent the voltage from damaging the crystal pickup. Simple, wasn't it? Nothing to it!

While hunting for the mica condensers she intended to use, Sally did more thinking. Suppose a condenser suddenly developed a short? Then what? This was Sunday. She had only this one crystal pickup. No, she certainly couldn't afford to experiment. Not under present conditions. Definitely, the crystal pickup had to go somewhere—some place where there was no B+ voltage. But where?

Looking through wiring diagrams of crystal pickup circuits had done her no good. They all were used with later radio receivers, which used AVC. If the Edison used AVC the job would be easy: she'd simply connect the pickup across the center and hot leads of the volume control in the radio. But the Edison had no Automatic Volume Control. Darn it!

Suddenly Sally understood what dad had meant when he'd said: "The ancient radio circuits are still brand new, to those who haven't learned the old circuits." Dad was right—as always. Dad could handle this job—easily. But dad was a thousand miles away, teaching radio to army personnel. No, she'd never bothered dad, with her troubles. And she certainly wasn't starting that now. Besides, she'd promised to finish this job today. And she would have the Edison ready—somehow.

Let's think, she decided. Let's think v-e-r-y s-l-o-w-l-y. That had been dad's advice every time she'd been baffled by a difficult radio repair job. She had to use the crystal pickup in a circuit in which there was no B+ voltage. That much was clear. Crystal clear—even if that was a pun!

After more thinking and more wrinkling of her straight little nose, Sally drew FIG. 3. There! The Detector grid carried no B voltage, so it was safe to try that idea.

(Continued on page 113)

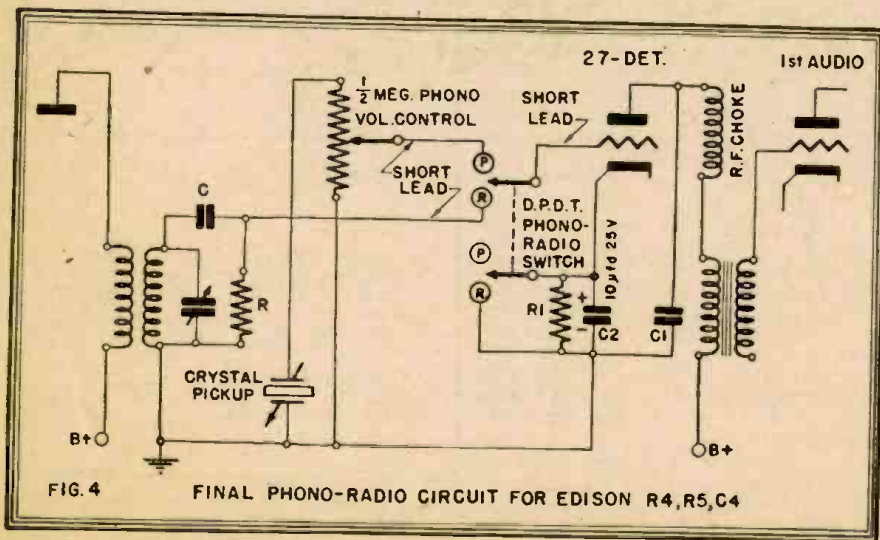



25 Years that Created a New World of Radio 1919-1944

From 1919 to 1944 . . . RCA has pioneered in the science of radio and electronics . . . from world-wide wireless to national network and international short-wave broadcasting . . . from electron tubes to electron microscopes and radiothermics . . . from the hand-wound Victrola to the automatic radio-phonograph . . . from television to radar.

Twenty-five years of service to the nation and the public have made RCA a symbol of achieve-

ment and progress . . . RCA is a monogram of quality in radio-electronic instruments and dependability in communications throughout the world.

From the First World War to the Second, RCA developed and expanded its "know-how" in skilled engineering and production so vitally needed to meet the demands of war . . . these qualities will be reflected in the peacetime products of RCA.

RADIO CORPORATION OF AMERICA

30 ROCKEFELLER PLAZA, NEW YORK CITY

RCA LEADS THE WAY . . . In Radio . . . Television . . . Phonographs . . . Records . . . Tubes . . . Electronics



25 YEARS OF PROGRESS
IN
RADIO AND ELECTRONICS

New Radio-Electronic Devices

FREQUENCY STANDARD

James Knights Co.
Sandwich, Illinois

CRYSTAL controlled with a hermetically sealed James Knights MD cut dual frequency crystal, a new Secondary Frequency Standard Instrument provides useful output up to 40 megacycles at 1000 kilocycle, 100 kilocycle and 10 kilocycle intervals. Operates from 60-cycle 115-volt line. The unit is attractively housed in a sturdy metal cabinet with gray crackle finish.—*Radio-Craft*



TRANSMITTING TUBE

Taylor Tubes
Chicago, Illinois

THE Taylor 803 is 9 $\frac{3}{8}$ " max. overall length by 29/16" max. diameter and is fitted with the giant 5-pin micaalex base.

Electrical tube characteristics are: Filament voltage 10 volts A.C. or D.C.; Filament Current 5 amps.; Interelectrode capacitances—grid to plate (with external shield) 0.15 mfd; Input 17.5 mfd, Output 29 mfd.

Operation data for R.F. Amplifier and oscillator: D.C. plate voltage 2000 volts, suppressor voltage (Grid No. 5) 500 volts, screen voltage (Grid No. 2) 600 volts, grid voltage (Grid No. 1) 500 volts, D.C. plate current 175 M.A., D.C. grid current 50 M.A., plate input 350 watts maximum, suppressor input 10 watts maximum, screen input 30 watts maximum, plate dissipation 125 watts maximum, driving power 2 watts approximately, power output 210 watts approximately. Maximum frequency at full output 20 megacycles. The tube may be mounted only in a vertical position with the base either up or down.

The Taylor 803 tube will be available solely for military and government orders on priority basis on war contracts.—*Radio-Craft*

SAFETY SWITCH GUARD

Cutler-Hammer, Inc.
Milwaukee, Wis.

CUTLER-HAMMER SWITCH GUARDS are designed to prevent the accidental operation of vital aircraft switches. Switches equipped with guards can be operated only with the full intention of the operator.

While the guard can be raised to permit normal operation, the switch lever is protected with the guard in place so that the switch cannot be operated unintentionally.

Guards are provided for both 2-position and 3-position switches and for types de-

signed for either flush mounting or one hole mounting, and to guard a switch either in the "off" or "on" position.

The guards used on circuit breakers are

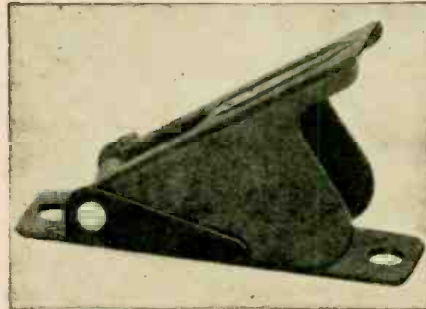

designed to prevent inadvertent operation of the switch. The guard must be raised in order to turn the circuit-breaker to the "on" position. When the guard is in the normal position the circuit-breaker lever is held in the "off" position.—*Radio-Craft*

BREAKDOWN TEST FIXTURE

Industrial Instruments, Inc.
Jersey City, N. J.

A SIMPLE, positive, safe and quick means of testing voltage breakdown of materials or components is provided by the Type P-3 Voltage Breakdown Tester.

Operating range of instrument is 0 to 10,000 volts D.C., or 0 to 8,000 A.C. A lower range instrument, Type P-1, with sloping panel, has a range of 0 to 4,000 volts D.C., or 0 to 3,000 volts A.C. The voltage is continuously variable over the entire range.

The voltage-breakdown tester operates directly from the 110-130 volt 50/60 cycle A.C. line. A panel light indicates when instrument is "On." Breakdown is indicated by a red signal light, while the built-in meter indicates the direct-reading voltage. Current-limiting resistors safeguard the equipment in the event of a dead short, by limiting the current to approximately 50 milliamperes. Uniformity over the entire range

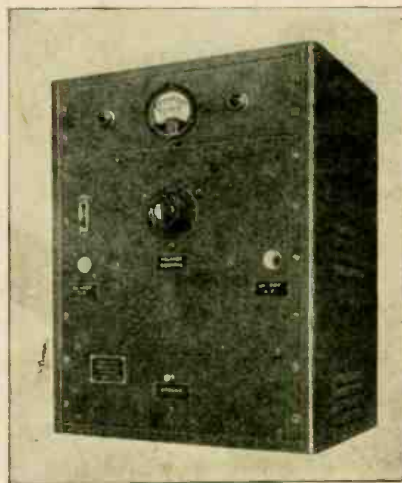

on this model P-3, or 5 milliamperes on model P-1. To speed up production testing, drawer-switch type fixtures are available.

The voltage-breakdown tester is housed in a fine-grained crackled 15 x 21 x 28-inch enamel metal cabinet.—*Radio-Craft*

ALIGNING INSTRUMENTS

General Cement Mfg. Co.
Rockford, Illinois

THE new TL-207 alignment tool is constructed of two basic parts molded from Durez Plastic. A scientifically designed barrel with small knurled head accommodates a spring controlled plunger with a larger control knob. The barrel is hexagonal shaped in its working end to accommodate the condenser adjustment lock nut. The plunger has a metal insert in its lower end resembling a screw driver tip. The spring prevents plunger tip from protruding beyond the hexagonal end of the tubular barrel. Minute adjustment is made by the plunger when it is pushed forward to mate itself into the cloven pin end of the condenser adjusting screw. Movement of the barrel quickly loosens or tightens the hexagonal locking nut which collars the condenser adjusting pin. Movements of magnitude and direction are indicated by the arrow

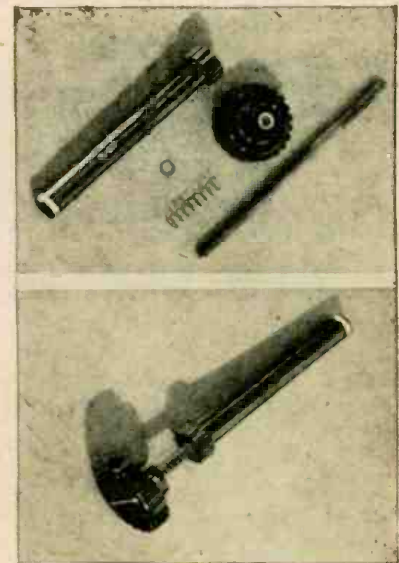

engraved on the control knob end. The new G-C aligning tool is being used by maintenance technicians with our overseas fighting forces.—*Radio-Craft*

PORTABLE SUPERTESTER

Radio City Products, Inc.
New York City

THE RCP. model 422 Supertester is equivalent to 27 individual instruments in one compact unit—with very low and very high ranges. Excellent for general circuit testing—speeds up trouble shooting—and combines many important measurements in one small case. Features are: Current measurements in both A.C. and D.C. up to 25 amperes; voltage measurements in both A.C. and D.C., up to 5000 volts; high voltage not applied to selector switch nor to general test circuits. 3-inch square meter with movement of 200 microamperes or 5000 ohms per volt sensitivity on D.C. voltage measurements. Resistance measurements up to 10 megohms. Batteries are replaceable without a soldering iron. Supplied complete with batteries in natural wood case—6 $\frac{1}{2}$ " x 7" x 2 $\frac{3}{4}$ "—with carrying strap handle.—*Radio-Craft*

SYLVANIA NEWS

RADIO RETAILER EDITION

NOVEMBER

Published in the Interest of Better Sight and Sound

1944

HUNDREDS OF PRIZES FOR RADIO RETAILERS

6th War Bond Drive Keyed to Pacific War

The coming 6th War Bond Drive will be geared primarily to the task facing us in the Pacific, according to Ted Gamble, National Director of the War Finance Division, U. S. Treasury.

"The job of the 6th War Loan," he told the merchant leaders, display experts and press representatives assembled at a luncheon sponsored by the War Advertising Council, "is to sell the war all over again to the people."

Charles W. Alexander, originator of the display plan, stressed the fact that the display contest was designed to give the participants maximum honor, prestige, and prizes.

CONTEST RULES

Contest begins when 6th War Bond Drive is officially announced by the U. S. Treasury. Display must be devoted exclusively to the War Bond Drive.

Photographs should be 8" x 10" glossy prints.

Photographs of displays should be marked "RADIO DIVISION" on reverse side, and followed by the name of the contestant, the name and address of the store, the dates when and place where display was on view to the public.

All photographs entered will become the property of the contest committee and will be presented to the U.S. Treasury for its use.

Photographs may be of one display or of a group; in the latter case 8" x 10" prints should be made of each display and joined together.

Entrants will receive acknowledgments from the committee shortly after receipt of the photograph.

Displays will be judged according to sales appeal, originality, attention appeal and artistry.

Sylvania Sponsors War Bond Display Contest \$1000—TOP PRIZE

Hundreds of Radio Service Shops and Radio Retailers from Coast to Coast will have the opportunity to win prizes totalling eight thousand dollars in War Bonds through the Sylvania-sponsored 6th War Loan window display contest. Confined to radio outlets—and *radio outlets only*—the chance of winning will be unusually high for every entrant. What is more, every entrant automatically qualifies for a *state, regional and national prize.*

JUDGES NAMED TO PICK WINNERS

Panels of judges are being chosen for each state, section, district, and for the nation. The panel will always include one representative of an advertising association, the advertising manager of a concern not competing, a public spirited citizen, a newspaper editor, and a commercial artist.

As the judges will have to make their decision according to what they see on the photographs submitted, Sylvania urges contestants to submit clear, sharp prints.

Ideas Count

Your window may be large or small; your shop may be on the main thoroughfare or a side street but to the judges the decision will be based on the cleverness of the idea and the ingenuity with which it is carried out.

Remember one thing—the window display is to be designed to *sell War Bonds*—not to advertise your services or Sylvania Electric Products, Inc. The more bond selling force you build into your window display, the more chance you have of walking off with one of the really big money prizes.

Who gets the Thousand Dollars

Some radio man is going to get himself a \$1000 War Bond. Hundreds of others will get smaller ones. Details are not all complete but write *today* to Sylvania, Emporium, Pa., and get in line for some real dough.

Sylvania will announce complete details of the contest to all dealers and servicemen by means of special mailings.



SYLVANIA ELECTRIC

PRODUCTS INC.

Radio Division • Emporium, Pa.

MAKERS OF FLUORESCENT LAMPS, FIXTURES, ACCESSORIES, INCANDESCENT LAMPS, RADIO TUBES, CATHODE RAY TUBES, ELECTRONIC DEVICES

RADIO-CRAFT for NOVEMBER, 1944

99

THE QUESTION BOX

A SMALL PRE-AMPLIFIER

Kindly show a diagram for a one-stage pre-amplifier, using a 6J7 and an independent power supply.—E.L., Conn.

A. The circuit shown should be satisfactory. Resistance is used instead of chokes in the filter system, as a means of reducing hum. This pre-amplifier may not be directly grounded, though if hum or hash persists a connection to ground through a 1-mfd. or larger condenser may help to clear it up.

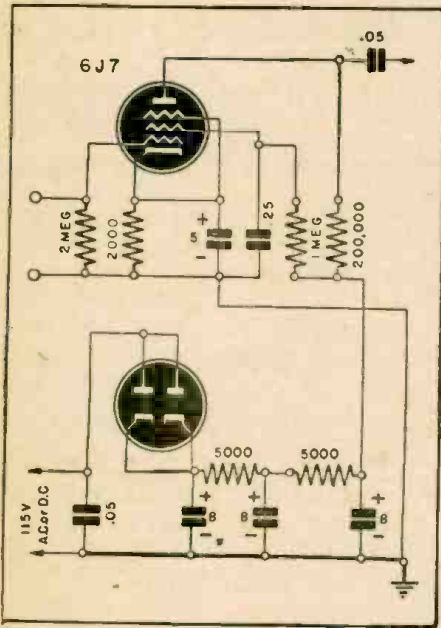

SHORT-WAVE CONVERTER

Please supply me with a circuit for a short-wave converter to work off the power supply of my receiver and to use ordinary plug-in short-wave coils.—D.M., Chicago, Ill.

A. This converter uses a 6A7 or 6A8 and a 6J5 or similar tube. The 140-mmf. condensers should be mounted on independent

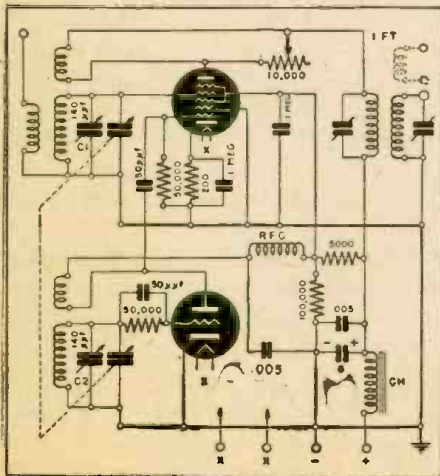

shaft—the smaller condensers shunted across them, ganged. These may be midget types with a maximum capacity of 30 mmf. or so. Identical coils may be used for the oscillator and aerial circuits, the difference in frequency being compensated for by the variable condensers.

If both main and trimmer condensers are ganged, the coils must be very carefully trimmed to track properly (see "The Tracking Problem" on page 85). A little trimming of the oscillator coil may be advisable in any case, so the two main dials may read alike.

The output transformer is an ordinary intermediate frequency transformer, but must be tunable to about 600 Kc. Several such are listed in the catalogs of various coil companies. It may be connected to the aerial post of the receiver, but if the first tube has a grid cap, a better connection is to remove the original grid lead and connect the output transformer direct to it. Another connection is to tune the output transformer to the I.F. of the receiver, and connect to the grid of the first I.F. tube. The coil shown in dotted lines may be wound with a few turns on the dowel of the I.F.T. and used for a connection to the doublet posts of certain receivers.

A SUPER-PORTABLE SET

I would like a diagram for a one-tube set, to be carried in a very small square box and to have no other aerial than a loop wound around the box.—J. B., Knoxville, Tenn.

A. The diagram here given will receive loud local stations on a loop. The box can be roughly 5 x 5 x 2 inches, with a loop of 39 turns, spaced 12 to the inch. The tickler may have 12 turns approximately, wound at the "ground" or filament end of the loop. Adjust the number of turns both in the tuning loop and the tickler, to spread the stations correctly over the dial, and to have oscillation at all points when the 50,000-ohm regeneration control is turned "full on." This may be done by increasing

or decreasing the number of tickler turns, or by varying the spacing between the two windings.

If an outside aerial is available, stations may be brought in much louder by attaching

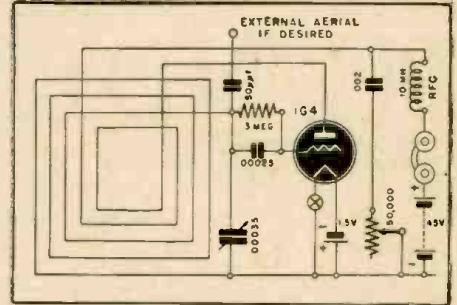

it to the aerial post shown. Even better would be two or three turns wound near the loop, with their ends attached to aerial and ground. This arrangement will not interfere with using the set as a straight loop receiver when no aerial is available.

The set as shown is insensitive, and should not be expected to receive any but moderately strong local stations on the loop.

Should an increase in signal with no corresponding increase in size be desired, a stage of audio amplification may be added. A small audio choke may be used for coupling, with another 1G4, or a 1G6 may be used for both stages (see last month's Question Box).

AMPLIFIER FROM PHILCO

I would like to make a phonograph amplifier from an old Philco radio, no longer in use. The output stage used two 42's.—C.D.R., W. Va.

A. The circuit shown uses only material taken from the Philco, with the possible exception of the tone control. It may be necessary to shield the input circuit as shown, and shielded lead should be run from the phonograph, with all shields and the chassis of the amplifier grounded.

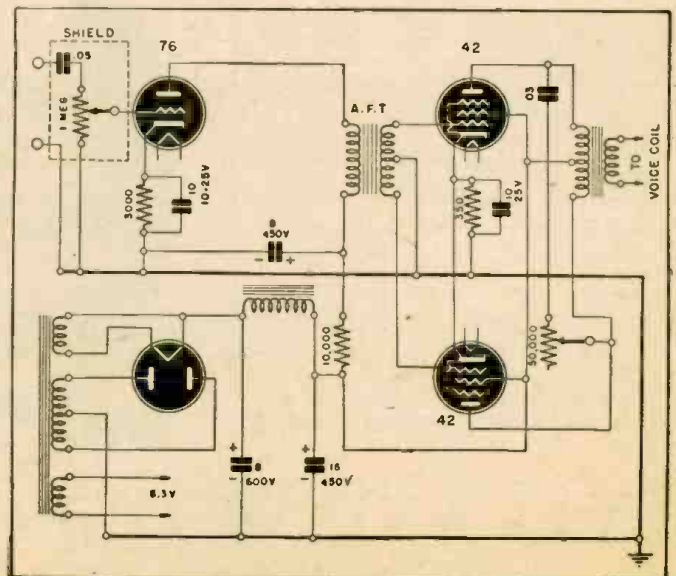

Right—amplifier with parts taken from an old Philco receiver. These sets had excellent tone quality and make amplifiers with fidelity little short of modern PA jobs. Input circuits must be carefully shielded and transformers positioned for minimum interaction to keep hum level low.

SPRAGUE TRADING POST

A FREE Buy-Exchange-Sell Service for Radio Men



REPLACING WET ELECTROLYTICS WITH DRYS

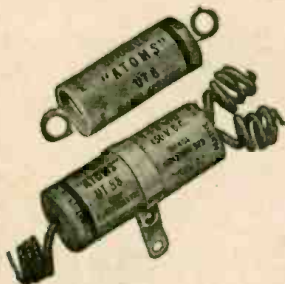

In many cases—particularly in old sets—you can use Sprague Atoms (midget dries) in available Victory Line types to replace unavailable wet electrolytic capacitors. Atoms stand the gaff! A few precautions should, of course, be observed, and these are described in the Sprague "Victory Line" Catalog C-304. Write for your copy today.

FOR SALE OR TRADE—Airline 6-tube electric radio; 7-tube electric radio; Jefferson tube charger. Want shop equipment or typewriter. B. Liehr, Box 243, Macomb, Ill.

WANTED—Second hand 2 or 3 tube receiver, preferably A-C. Not more than \$4. William Naxy, 12 The Circle, Hornell, New York.

FOR SALE OR EXCHANGE—National electric Hawaiian kuitar, complete. Want test equipment. Geo. W. Miesinger, Box 15, Nuremberg, Pa.

SWAP OR SELL—Superior channel analyzer, almost new. Want 12SA7, 1A & 12A8 tubes, new. Willard J. Smith, St. Ignace, Mich.

FOR SALE—RK20 tube, Raytheon \$41, pair of 58's; also Bruno VR-HP velocity microphone. H. V. Cushing, 2326—25th St., S.E., Washington 20, D. C.

WANTED—Sig. generator, oscilloscope, and channel; also a 8X16 or 8X17, in good shape. C. E. Sheffer, 40 Phila. Ave., Waukesha, Wis.

FOR SALE OR TRADE—Weston meter, DC-0-150v.; Philco shadowgraph, 7v. tubes, and misc. radio parts. Want Rider manuals and oscilloscope. A. N. Johnson, 110 Virginia St., Baytown, Texas.

URGENTLY NEEDED—Multimeter and sig. generator, with instructions. Must be A-1. Roosevelt Ross, 731 Rose St., Jackson, Miss.

WANTED—Set of used Rider manuals, RCA voltmyst, jr., late tube tester, Edward Budnik, 647 Maridell N.W., Grand Rapids 4, Mich.

FOR SALE—New G.I. recorder, playback unit, 2 speed, \$45; 2v. Porta-power-Back No. L, \$12; Western Electric oil damped pick-up, \$8.50; new Utah PM trumpet unit, \$25; Astatic mikes; new special 15" p.m. speaker in baffle box-wire mesh grill, \$35; like new cineragraph, 18" p.m. speaker, \$75; etc. M. A. Porter, 1713 Larrabee St., Chicago, Ill.

WANTED—"Official Radio Service Handbook"—1936 ed. by J. T. Barnsley; also circuit diagram of Confidence Special Tube Tester No. 8343, and modernizer transformer to test tubes 30 to 117r. C. B. Rodgers, R.F.D. 4, Box 107, Delaware, Ohio.

WANTED FOR CASH—15" or 18" electro dynamic or P.M. speaker. Tillman Ray, R. No. 1, Abingdon, Va.

WANTED—V-O-M in A-1 condition; tube tester, output meter, and all-wave oscillator. Fernando Jimenez, 1524 Amsterdam Ave., New York 31, N. Y.

WANTED—Oscillator, 2 telegraph keys, and 2 headphones. Robert Carter, Jr., P.O. Box 225, Pascagoula, Miss.

FOR SALE—New PCA 800, new RCA 914, two Taylor T-53 and one Elmac 75-T (used but good)—\$25 f.o.b. for the lot. Wm. Worland, 606 Martin St., Greenville, Ohio.

WILL TRADE—Brand new Winchester 22 automatic; want good recorder mechanism. Haskins Radio Service, 617 Fourth St., West De-Pere, Wis.

WANTED—351AGT and 13SA1GT tubes. S. M. Watts, Y.M.C.A. Rm. 542, St. Paul, Minn.

WILL SELL OR SWAP—Radio Products No. 54 set tester in A-1 condition, \$30 e.o.d. also mls. meters, tubes, books, etc. Want Simpson 4941 No. 320 V-O-M or Hlekok No. 4922-S jumbo V-O-M. Radio Research Lab., 30 Union St., Watertown, Mass.

WANTED—Hlekok 510X tube tester and Hlekok 188X sig. generator. S. V. Koen, 411 S. Barranca Ave., Warrington, Fla.

WANTED—University 25-watt speaker. Bill White, P.O. Box 97, Eagle Lake, Fla.

URGENTLY NEEDED—Pair of good headphones (not more than \$1.25). Lylo Sandin, 74 Wall St., Binghamton, N. Y.

FOR SALE—Complete radio service shop—only one in town of 12,000—excellent location, good stock of parts and tubes, well equipped. Jack's Radio Shop, 1230 "G" Avenue Douglas, Arizona.

URGENTLY NEEDED—Up-to-date analyzer, Weston 600 or equivalent. Phil Werking, R.R. 3, North Manchester, Ind.

FOR SALE OR TRADE—Four 12" frequency recorders and 0-1 voltmeter. Want radio testers, photo enlargers, or cameras. Mill Farber, 454 Ocean Ave., Jersey City 5, New Jersey.

WANTED—Two I.F. transformers, preferably Meissner 16-6660 and 16-6658, 465 Kc. Girard Fude, 308 Irving Ave., Syracuse, N. Y.

FOR SALE OR TRADE—Weston 770 tube checker, in A-1 condition \$25. Want good V-O-M or sig. generator. G. R. Hodgson, Beacom, Ohio.

WANTED—Test and service equipment of all kinds for service shop, starting from scratch. Sam Davenport, Jr., 523 Shastown St., Pasco, Wash.

WILL TRADE—RCA synchronous variable speed AC motor and 12" turntable as part payment for a recording motor with 10" turntable and recording head. James F. Morgan, 811 Park Ave., Anderson, Ind.

WANTED—0 to 1 ammeter A-C, and 50 microampere meter D-C. Weston or Triplett No. 301, or larger. Also need VT voltmeter. John L. Campbell, 2034 East 28th St., Brooklyn 29, N. Y.

WANTED—Multimeter tester in good condition. J. Robinson, Box 605, Tallulah, Ga.

WANTED FOR CASH—RCP No. 414 or 419 multimeter, bench or portable. Ray Knoepfer, 1059 Rockman Place, Rock Hill 19, Mo.

WANTED—Sky Buddy 8-19R receiver for cash. Morton Barfield, 4 Brinsley St., Dorchester 21, Mass.

WILL TRADE—One 913 cathode ray tube (RCA) for phono pick-up, preferably Audax. William Macnes, 154 Woodland, Campbell, Ohio.

WANTED—Modern tube tester analyzer, signal tracer, and Rider's manuals. WILL SWAP No. 220 Imperial multimeter, in A-1 condition, for what have you? Pat Smith, 615 Woodlawn Ave., Rockford, Ill.

WILL SWAP—Brand new pair GE-810 transmitting tubes for 200-watt vari-tap modulation transformer. Leland B. Firman, 707 North Broadway, Wichita 5, Kans.

WANTED—Compl. electric record chucker units, new or used, but in good condition ready to install. Types suitable for home radio-phonograph combinations. Checker Stores, Inc., Court & Race Sts., Cincinnati, Ohio.

WANTED—Rider manuals 1 to 9 inc.; also No. 188X Hlekok oscillator, No. 155, Hlekok sig. tracer, and Wright DeCoster test speaker. Herrick Radio Service, 1010 Madison Ave., Toledo 2, Ohio.

WANTED—Urgently in need of 0-1 ma. meter. Cash—or will trade. Have 5 telephone transmitters and most hard-to-get tubes & parts. Timmy Vickers, 39 Prospect Ave., Sausalito, Calif.

URGENTLY NEEDED—S-29 Hallcrafters communication receiver. Pvt. J. Leonard King, No. 970, 812, 2nd Eng. Bn. Co. B, Inf. Tng. Regt. T.C.-F.M.F., Camp Pendleton, U.S. M.C., Oceanside, Calif.

WILL TRADE—Howard No. 460 comm. receiver. A-1 condition, complete with 13 tubes, preselector, loop kit, etc. Want Hlekok RFO-5 scope. Earl D. Kent, Mountain Home, Idaho.

WANTED—Phono recording and playback unit with crystal or mag. cutting head. Vanardy Cloutier, P.O. Box 1, Salida, Calif.

FOR SALE—PA system in A-1 shape, has not been used, 35-watt Air Line. All inquiries answered. Square Deal Radio & Elec. Service, Benton, Ky.

WANTED—V-O-M or comb. tube checker in good shape. Prefer Weston or Hlekok. Charles H. Walker, 616 So. 2nd St., Union City, Tenn.

FOR SALE—8W3 receiver, complete with tubes, power supply, 20-40- and \$0-meter coils, all A-1. \$35. Frank Bou, 3131 N. Percy St., Philadelphia, Pa.

FOR SALE—One No. 10 and two 81 tubes, slightly used. J. W. Wodjick, 65 Main St., Pittston, Pa.

FOR SALE OR TRADE—EC-1 receiver; Stanco 10P phone transmitter; Millen 90800 exciter unit with coils and tubes; Packard Portable automatic record player. Want Abbott 2 1/2 M transceiver, II F. 7 frequency standard, 155A oscilloscope, or equivalent. G. Stephen Beck, Roosevelt, New York.

FOR SALE—43 new and 57 slightly used tubes—many critical types. No part orders. Write for list. E. L. Pope, 1305 "A" Frausere Circle, Marietta, Ga.

URGENTLY NEEDED—SX-28 Hallcrafters' Pvt. J. Leonard King, 2nd Trng. Bn. Co. B, Camp Pendleton, Oceanside, Calif.

WANTED—Late model, all-purpose Multimeter or multimeter, in one cabinet. Hubert Reates, Newport News, Va.

FOR SALE—Jewell 1-6 v. D.C. meter, Weston meter, 8" P.M. speaker, and the following tubes: 9001, 9002, 30, 6SK7, 645, 714 and 76, Sam H. Porter, 606 N. Lincoln, Bay City, Mich.

FOR SALE—New G.I. recording unit, complete, \$23.50; Zenith vibrator packs, \$3.50; long list new and used tubes in wanted types. J. C. Cagle, Okenee, Okla.

URGENTLY NEEDED—Precision No. 844 V-O-M, Simpson No. 280 voltmeter, Jackson No. 650-A condenser and other test equipment—what can you offer? John Lubinski, 3349 Fulton, R.D. 9, Cleveland, Ohio.

FOR SALE OR EXCHANGE—Weber No. 50 tube tester, Weber No. 60 tube tester, and Superior channel analyzer with V.T. V.M. Want Triplet No. 1213 tube tester, Triplet No. 1232A sig. generator or No. 1200Q V-O-M, Lloyd Johnson, 4314 Nicollet Ave., So. Minneapolis 9, Minn.

WANTED—Western Electric 10A tuner. F. Hendrickson, Mamaroneck, N. Y.

FOR SALE—Supreme No. 339 radio analyzer, \$20; No. 420 tube tester, \$15. Frank's Appliance Service, 4843 S. Winchester Ave., Chicago, Ill.

YOUR OWN AD RUN FREE!

This is Sprague's special wartime advertising service to help radio men get needed parts and equipment, or dispose of radio materials they do not need. Send your ad today. Write **PLAINLY**—hold it to 40 words or less. Due to the large number received, ads may be delayed a month or two, but will be published as rapidly as possible.

Sprague reserves the right to reject ads which do not fit in with the spirit of this service.

HARRY KALKER, Sales Manager

SPRAGUE PRODUCTS CO., DEPT. RC-114, North Adams, Mass.
(Jobbing distributing organization of products manufactured by SPRAGUE ELECTRIC COMPANY)

SPRAGUE CONDENSERS * KOOLOHM RESISTORS

Obviously, Sprague cannot assume any responsibility, or guarantee goods, services, etc., which might be exchanged through the above advertisements

*TRADEMARK REG. U.S. PAT. OFF.

Radio-Electronic Circuits

VOLUME INDICATOR

Here is a tuning-eye volume indicator for recording which works very well.

The circuit is built into a public address system that I designed and it works particularly well to show me whether I am operating at fullest capacity. The input is through a .01 condenser to the plate of the last tube, usually a 6L6 or a 6V6, but when making this connection be sure to connect to only one plate—not both as in many volume indicator circuits.

A purist may say that this set-up will throw the last stage out of balance, but in actual practice I can see little or no difference in the hum level or the fidelity of the amplifier because of the connection.

R. W. WEST,
Decatur, Ill.

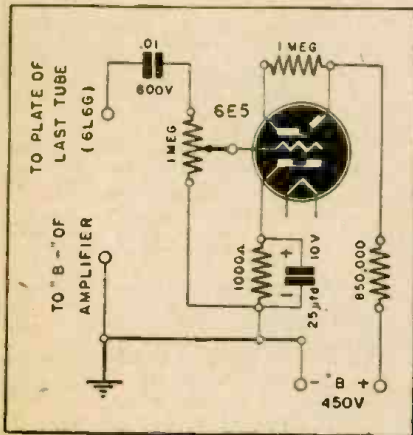

MULTI-USE AMPLIFIER

I have built several of these amplifiers and I must say I haven't had any complaints about them. I also have one of them in shop. It has two speakers in the shop and one in my house, so I have music in both places and can also call anyone in the house. I can take it out of the shop any time I have a call for a PA system as well, so it earns its keep better than any other piece of equipment I have.

L. W. EMBLY,
Hagerstown, Md.

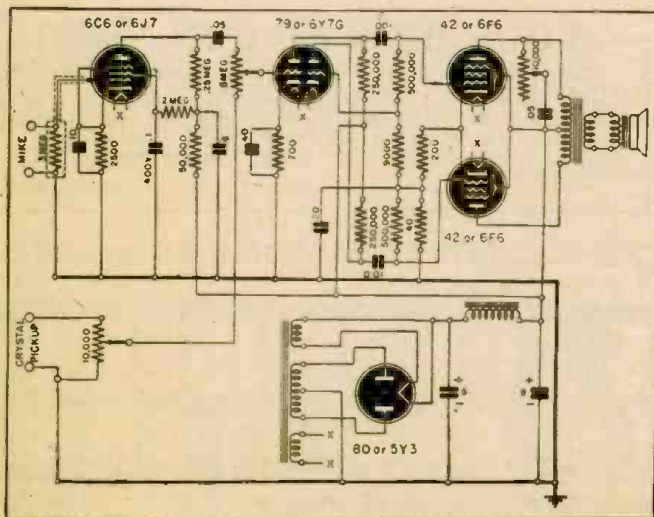

RADIO-CRAFT welcomes new and original radio or electronic circuits. Hook-ups which show no advance on or advantages over previously published circuits are not interesting to us. Send in your latest hook-ups—RADIO-CRAFT will extend a one-year subscription for each one accepted. Pencil diagrams—with short descriptions of the circuit—will be acceptable, but must be clearly drawn on a good-sized sheet of paper.

COMPACT PRE-AMPLIFIER

This compact pre-amplifier will prove itself extremely useful when it is desired to operate a crystal mike or some type of photo-electric cell unit with an amplifier that does not provide enough gain.

It requires no internal connections to the existing amplifier. Just connect the output to the pickup input terminals and plug in the power. For minimum hum try reversing the power plug.

JACK MASSEGAR,
Huntington Park, Calif.

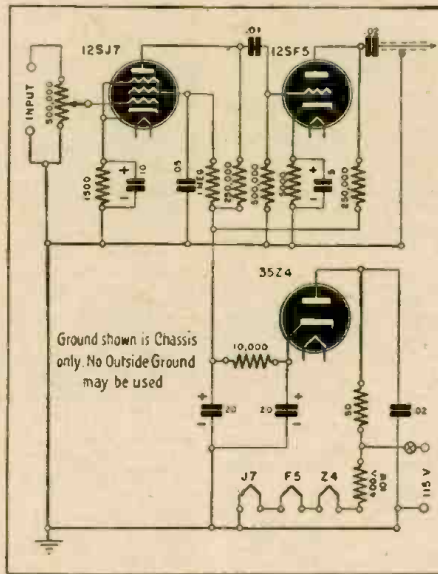

ONE TUBE RECEIVER

This set uses two dry cells and a 30 type tube. It is very simple to construct and has given good results.

The circuit is a split Hartley, shunt-fed type. With some headphones it may need a R.F. choke between the plate and headphones.

It might be hooked up with a 1.4 volt tube if it has a regeneration control, either a feedback or throttle condenser, or a resistance in the plate circuit.

REGGIE BAKER,
Miami, Arizona.

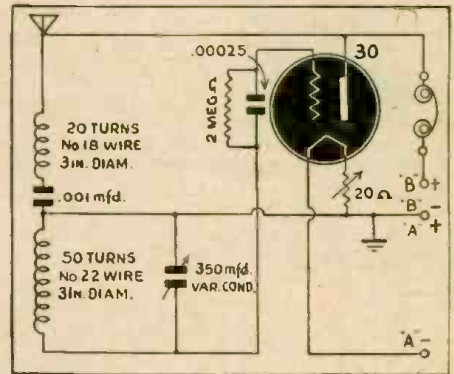

HARTLEY PHONO OSCILLATOR

This circuit is a Hartley parallel feed, one that I have not seen used on a phono oscillator before.

The 6A8 or 12A8 tube acts as an R.F. oscillator and a mixer. The audio frequencies from either a microphone or pickup are fed into grids 1 and 2, thus modulating the continuous waves produced by the other elements of the tube.

Coil L1 is wound with 150 turns of No. 30 copper enamelled wire. It is tapped at the 90th turn for connection to the cathode.

If condenser C1 is calibrated, this set may be used as a signal generator using either phonograph music or the output of an audio oscillator to modulate the signal. The audio oscillator output is of course fed into the circuit through the same input terminals as the phono.

RALPH DAY,
Moncton, N. B.

Left—Shop and P.A. amplifier. Below—A Hartley phono oscillator.

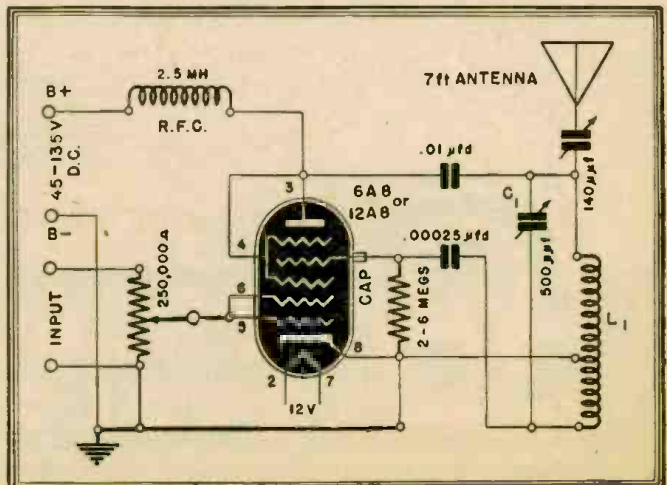

Which of these
NEW AND STANDARD
McGRAW-HILL RADIO BOOKS
will help you most?

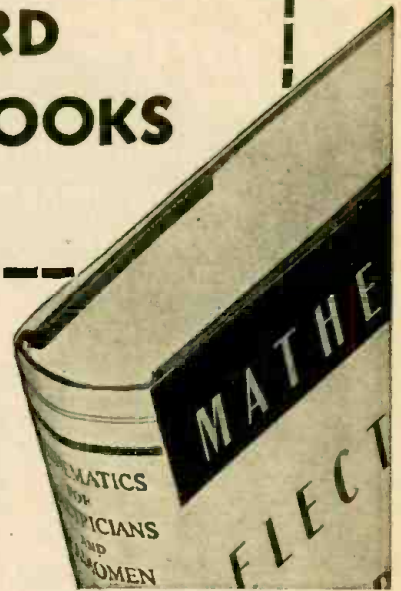

1. Mathematics For Electricians and Radiomen

Brings you the math you need to solve everyday radio and electrical problems—right out of the U. S. Naval Radio Materiel School at the Naval Research Laboratory. Teaches you elementary algebra through quadratic equations, logarithms, trigonometry, plane vectors and elementary vector algebra with direct applications to electrical and radio problems. By NELSON M. COOKE, U. S. Navy. 604 pages, illustrated, \$4.00.

2. Understanding Radio

An ABC book on radio with a sound technical background. Covers the radio field from the very beginning. Gives you a complete basic understanding of radio receivers and transmitters including the ability to construct and test the various types, and a knowledge of the principles that make each part work and how they work together. Has close likeness to personal instruction, combining instructions, construction, experiments, and explanation of results at every step. By H. M. WATSON, H. E. WELCH, and B. S. EBY, Stockton Junior College. 601 pages, 406 illustrations, \$2.80.

3. Radio Engineers' Handbook

A wealth of essential theory and standards, practice and data, especially selected and organized to meet the needs of the engineer dealing with practical radio and electronic problems. Comprehensive and detailed, gives 13 big sections of carefully selected and authoritative facts on problems of research, design, or application in radio engineering. Consult this Handbook for data on routine problems or in investigation of special problems or branches of work. By FREDERICK E. TERMAN, Harvard University. 1019 pages, 869 illustrations, 84 tables, \$6.00.

4. Graphical Constructions for Vacuum Tube Circuits

Presents vacuum tube circuits and problems mainly from the graphical point of view. This approach helps in the solution of actual problems and also presents visually the mode of operation of the tube. In particular, the nonlinear nature of vacuum tube problems is stressed. Recent advances are taken into account in the treatment of many topics such as balanced amplifiers, detectors, and inverse feedback. By ALBERT PREISMAN, Capitol Radio Engineering Institute. 237 pages, 125 illustrations, \$2.75.

5. Basic Radio Principles

Here are full explanations of the major radio theories and actual radio equipment, showing the construction and function of the composite parts of radio equipment for practical radio work as repairman, technician, or operator. The manual begins with the most fundamental radio theory, goes on to more particularized discussions of radio theory and equipment, and shows how to recognize and interpret radio symbols and understand the way the individual symbols are joined together to form a circuit. By CAPT. MAURICE G. SUFFERN, Signal Corps, U. S. Army. 271 pages, 259 illustrations, \$3.00.

6. Radio: Fundamental Principles and Practices

For a basic understanding of radio functions necessary for any type of practical radio work. Explains briefly and concisely electron theory, current, vacuum tubes, inductance, capacitance, resonance, circuits, amplifiers, transmitters, antennas and transmission lines. By FRANCIS E. ALMSTEAD, Lieutenant, U. S. N. R., KIRKE E. DAVIS, Oceanside High School, Oceanside, N. Y., and GEORGE K. STONE, The State Education Dept., Albany. 219 pages, 174 illustrations, \$1.80.

7. A Primer of Electronics

An ABC book for electricians, servicemen, salesmen, dealers, all whose work touches on the manufacture, sale, or operation of industrial and household devices based on electronics. Without formulas or much mathematics explains electronic tubes and circuits, and how they are applied in working devices. Covers static and electron discharges, electric current, magnetism, electromagnetic radiation, radio tubes, fluorescent lamps, cathode ray tubes, etc. By DON P. CAVERLY, Sylvania Electric Products, Inc. 235 pages, 125 illustrations, \$2.00.

8. Radio Direction Finders

For all concerned with the design, procurement, or operation of radio direction finders for aircraft, shipboard, or fixed station use, this book covers wave propagation, directive antenna systems, aural null direction finders, performance characteristics of loop input circuits, visual direction finders and radio navigation aids. By DONALD S. BOND, Radio Corporation of America. 287 pages, \$3.00.

10 DAYS' FREE EXAMINATION

SEND COUPON

McGRAW-HILL BOOK CO., INC., 330 West 42nd Street, New York 18, N. Y.

Send me books encircled below for 10 days' examination on approval. In 10 days I will pay for books, plus few cents postage, or return them postpaid. (Postage paid on cash orders.)

1 2 3 4 5 6 7 8

Name

Address

City and State

Position Company RC 11-44

(Books sent on approval in the United States only.)

TRY THIS ONE!

Proven!
25,000 OHMS PER VOLT
PUSH BUTTON OPERATED
SPEED TESTER
SUPREME MODEL
592



- ★ Design proven by over 5 years production
- ★ Dual D.C. Sensitivity—25,000 ohms per volt and 1000 ohms per volt.
- ★ Matched resistors of 1% accuracy
- ★ Push button operated—no roaming test leads
- ★ Open face—wide scale 4 1/4" meter. 40 microamperes sensitivity.
- ★ 1 Microampere first scale division.

SPECIFICATIONS

D.C. MICROAMPERES:
 0-70-700 microamperes
 D.C. MILLIAMMETER:
 0-7-35-140-350 milliamperes
 D.C. AMMETER
 0-1-4-14 amperes
 D.C. VOLTS, 25,000 OHMS PER VOLT:
 0-3-5-7-35-140-350-700-1400 volts
 D.C. VOLTS, 1000 OHMS PER VOLT:
 0-3-5-7-35-140-350-700-1400 volts
 A.C. VOLTS, 1000 OHMS PER VOLT:
 0-7-35-140-350-700-1400 volts
 OUTPUT VOLTMETER:
 0-7-35-140-350-700-1400 volts
 DECIBEL METER:
 0 db to plus 46 db
 OHMMETER:
 0-500-5000-50,000-500,000 OHMS
 0-5-50 MEGOHMS
 POWER SUPPLY
 Battery Operated

With the above specifications the Supreme Model 592 Speed Tester meets today's requirements for general laboratory use, assembly line tests and inspection, radio and other electronic repair and maintenance.

SUPREME
TESTING INSTRUMENTS

SUPREME INSTRUMENTS CORP.
 Greenwood, Miss., U. S. A.

CUTS CONDENSER CAPACITY

This plan will change an ordinary broadcast condenser into a low-capacity type.

A trimmer is connected in series with the broadcast condenser. This lowers the capacity, the amount depending on the size of the series condenser.

To change a 365-mmfd to a 140-mmfd condenser, use a 200-mmfd condenser in series. A mica condenser or a trimmer type will do. For a 100-mmfd condenser use 150-mmfd in series, and for a 75-mmfd condenser, 100 mmfd.

This will work either with a single condenser or with a ganged unit.

EDWIN BOER,
 Chatanooga, Tenn.

TONE AND VOLUME CONTROL

Here is an idea for a tone and volume control to be inserted between a crystal pickup and the first amplifier tube. I believe it to be "tops" for us fellows who don't have any too much testing equipment to plot response curves and impedances. It is an adaption from a circuit given in the Radiotron Designers Handbook (RCA).

Looking into the filter network from the crystal pickup, there is a definite total impedance to each frequency which is desirable from the standpoint of fidelity and being pleasing to the individual listener. In this tone control the 500,000-ohm potentiometer provides the necessary impedance match with variable treble attenuation.

In operation, turning the 500,000-ohm potentiometer toward the treble response end will produce increasing degrees of brilliance in the music and an apparent increase in volume. The volume can then be adjusted to suit your conditions. Working the potentiometer toward the bass response end will produce an apparent bass boost when equalized with the volume control.

The beauty of the network is that a place can be found where the surface noise from the record is largely eliminated but yet a good response will be retained for the higher frequencies in the music. If you find that the total treble attenuation is too great, substitute a .006 Mfd. condenser in the place of the .01.

Needless to say, both the 500,000 ohm potentiometer and the 1 Meg. Volume control should both be of a very good grade and as noiseless in operation as possible, because any noise introduced here is amplified by the entire gain of the amplifier.

NORMAN V. CHURCHILL,
 Wheaton, Illinois

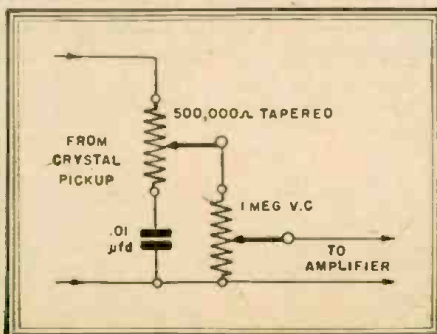

HOME-MADE COIL SWITCH

The illustration is self-explanatory and shows a very good arrangement for short-wave sets. The contacts of the coil forms make good contact on the connectors.

(Ed. Note) For those who prefer the three separate circuit scheme, that is, primary, secondary, tickler, a six-prong form could be used instead of the four.

JOHN MILLSAPS, JR.
 San Antonio, Texas

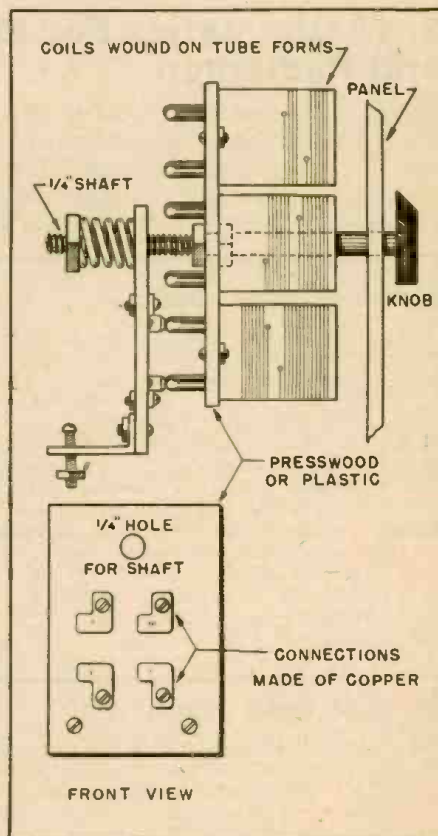

FIXED CRYSTAL DETECTOR

Obtain one of the very many types of adjustable crystal detectors available. Polish the end of the catwhisker with sandpaper and find the most sensitive spot.

Now let fall a drop of Collodion, such as is used in aeroplane model making, and you have a fixed sensitive detector that will last for years without needing adjusting.

JOSEPH D. AMOROSE,
 Richmond, Va.

RESHAPING SPEAKER CONES

In almost all cases of out-of-round voice coils on speaker cones, it has been my observation that tubular electrolytic and bypass condensers make excellent forms for reshaping.

By inserting a tubular condenser into the voice coil, and applying cement, it can be made nearly perfectly round. Most tubulars are coated lightly with wax, which allows ample use of speaker cement in reshaping the coil, without fear of the coil sticking to the form.

S/SGT. ROBERT W. HESTER,
 San Antonio, Texas

HOGARTH DOESN'T MIND—HE'S USED TO HAVING
A CROWD AROUND HIS **ECHOPHONE EC-1**

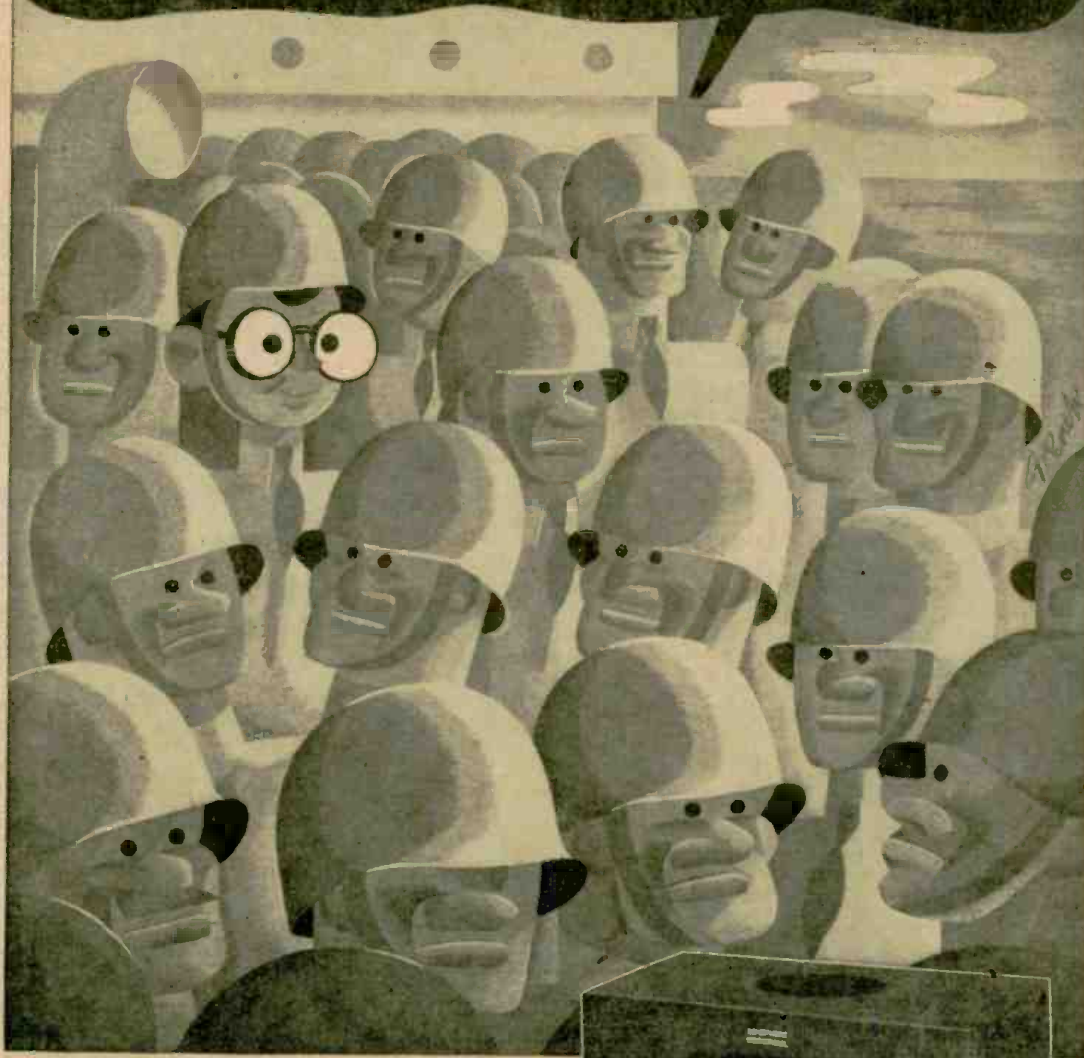

ECHOPHONE MODEL EC-1

(Illustrated) a compact communications receiver with every necessary feature for good reception. Covers from 550 kc. to 30 mc. on 3 bands. Electrical bandspread on all bands. Six tubes. Self-contained speaker. 115-125 volts AC or DC.



ECHOPHONE RADIO CO., 540 NORTH MICHIGAN AVE., CHICAGO 11, ILLINOIS

WHAT'S YOUR IDEA OF THE
IDEAL POST-WAR RADIO &
TELEVISION **SERVICE
BENCH**

Every Month!
\$100 in WAR BONDS
Given For **BEST LETTERS!**

★ Each Month's 1st Prize,
a \$50 Bond, 2nd and 3rd
Prizes each a \$25 Bond.

Contest Now in Progress.
Ends December 31, 1944.

★ **THINK OF IT—**

You can win a War Bond just by putting down your ideas as to what the ideal post-war Radio Service Bench should be. How many and what type of testing instruments for use on Radio, F-M, Television and so forth. How it must be arranged to render most efficient service—confidence. Your Ideal Service Bench.

★ **ANYONE CAN WIN—**

You can win. We want opinions from everyone interested in Radio and Television Service—Old Timers—Beginners. Experience will help—new-comers with good ideas can win.

★ **ENTER EACH MONTH—**

If you don't win this month, write again next month—and next—until the contest closes. Remember, it is your opinion that wins, not literary ability. It's Easy to Enter and the Rules Are Simple! Get That Letter Off to Us Today!

RULES OF THE CONTEST

- Simply write a letter (500 words or less) on the subject: "My Idea of the Ideal Post-War Radio and Television Service Bench."
- Contest is open to all readers of *Burlingame Craft* (excepting employees of *Burlingame Associates*, their relatives, or their Advertising Agency).
- You need not own a Radio Shop or possess any of the equipment you describe.
- No detailed technical description of the apparatus is required.
- Mention of elaborate testing equipment suitable only for exhibition use will detract from the value of the letter. The inclusion of useful, confidence-creating apparatus, however, is recommended.
- Literary ability is not required. Anyone writing in understandable English, giving a good word description, has an equal opportunity of winning one of the prizes.
- Write only on one side; sign your name and address CLEARLY in the upper-right-hand corner; number each sheet.
- Contest runs 6 months, July 1, 1944, through December 31st, 1944. Each month's contest begins first of that month with deadline for entries the last day of that month. Enter as often as you like.
- No letters will be returned. Letters, contents and ideas contained therein become the property of *Burlingame Associates*.
- Judges' decisions will be final and duplicate prizes awarded in case of ties.

SEND ALL ENTRIES TO
**BURLINGAME
ASSOCIATES**

10 MURRAY STREET—NEW YORK 7, N. Y.

World-Wide Station List

Edited by ELMER R. FULLER

WITH the coming of fall, we should see many changes in atmospheric conditions, and in reception of short-wave radio stations. The lower frequencies will be opening up during the evening, and reports should begin to include many schedule changes in this region of the short-wave bands. Listeners will find it worth while to tune over these spectra.

We could still use a few more observers throughout the country, as we need many reports to keep our station list up to date as much as possible. The listening post

certificates are about ready and will be in the mail at an early date. I have received a proof of them and they will do justice to any shack.

The crop of new stations and the "under new management" sign are seen and heard more and more as the Allied Nations march forward, sweeping their enemies before them. Watch for new ones, and for the old ones coming back. It won't be long before American and British engineers will be running Hitler's stations but for us, and not Adolf.

Schedules below are Eastern War Time.

Mc.	Call	Location and Schedule	Mc.	Call	Location and Schedule
4.895	YDP3	SOERABYA, NETHERLANDS IN-DIES.	11.79	—	"RADIO PRAHEVA."
5.935	PJC2	WILLEMSTAD, CURACAO; Satur-days only, 12 to 12:45 am.	11.80	JZJ	TOKYO, JAPAN.
6.000	ZOY	ACCRA, GOLD COAST; 10 pm to 1 am.	11.820	GSN	LONDON, ENGLAND; afternoons and evenings.
6.100	XGAW	JAPANESE CONTROLLED CHINA; heard irregularly at 1 to 3:30 am.	11.820	CX11	COLONIA, URUGUAY.
6.150	CJRO	WINNIPEG, CANADA; heard at midnight; sked not known.	11.830	WCRC	NEW YORK CITY; West South America beam, 5:30 pm to mid-night; European beam, 7 am to 5:15 pm.
6.910	YNOW	MANAGUA, NICARAGUA.	11.840	DHE4B	PODIEBRAD, BOHEMIA; on at 6 pm; sign-off unknown.
7.160	HC1BF	QUITO, ECUADOR.	11.845	—	VICHY, FRANCE.
7.86	SUZ	CAIRO, EGYPT.	11.847	WGEX	SCHENECTADY, NEW YORK; Eu-ropean beam, 6 to 11:45 am.
9.360	CBFX	MONTREAL, CANADA; 7:30 am to 11:30 pm.	11.847	XMHA	SHANGHAI, CHINA; 9 to 10 am.
9.600	XAEW	MEXICO CITY, MEXICO; heard late afternoons and evenings.	11.847	WGEA	SCHENECTADY, NEW YORK; Eu-ropean beam, noon to 4:45 pm; Brazilian beam, 5 to 11:30 pm.
9.740	—	"RADIO FRANCE"; heard at 4:30 to 4:50 pm.	11.855	DJP	BERLIN, GERMANY.
11.000	PLP	BANDOENG, NETHERLANDS IN-DIES.	11.86	ZPA6	VILLARICA CITY, PARAGUAY; news in Spanish 8 pm.
11.040	CSW6	LISBON, PORTUGAL; Brazilian beam, 6:45 to 8:45 pm.	11.870	WN81	NEW YORK CITY; East South America beam, 7 pm to mid-night; Sundays only, 7:45 pm to midnight.
11.090	—	PONTA DEL GADA, AZORES; heard at 2:45 pm.	11.870	KWID	SAN FRANCISCO, CALIF.; Au-stralian beam, 4:15 to 6:30 pm.
11.145	WCBN	NEW YORK CITY; European beam, 5:30 to 7:15 pm.	11.870	WOOW	NEW YORK CITY; European beam, 7:45 to 9 pm; 5:15 to 6:45 pm.
11.410	—	"RADIO DAKAR"; FRENCH WEST AFRICA; 3 to 5 pm.	11.870	WBOS	BOSTON, MASS.; European beam, 5:45 to 7:30 am.
11.470	—	"VOICE OF FREE INDIA"; 11:35 am to 12:05 pm.	11.88	VLR3	MELBOURNE, AUSTRALIA; 1 to 3:15 am.
11.500	VPL10	BARBADOS, BRITISH WEST IN-DIES; heard testing on a Sunday afternoon.	11.88	LRR	ROSARIO, ARGENTINA.
11.535	DZA	BERLIN, GERMANY.	11.893	WRCA	NEW YORK CITY; European beam, 3 to 4:45 pm; 5 to 9:45 am.
11.616	COK	HAYANA, CUBA; noon to mid-night.	11.897	JVU3	TOKYO, JAPAN.
11.633	—	"HUNGARIAN NATION RADIO."	11.900	KWIX	SAN FRANCISCO, CALIF.; South America beam, 6:45 pm to mid-night.
11.68	GRG	LONDON, ENGLAND.	11.900	XGOY	CHUNGKING, CHINA; Allied Forces in the Far East beam, 8 to 9 pm; Asia-Australia-New Zea-land beam, 6 to 6:30 am; East Russia beam, 6:30 to 7 am; Japan beam, 7 to 7:30 am.
11.69	XGR5	SHANGHAI, CHINA; 11:15 am to 12:30 pm.	11.930	—	LONDON, ENGLAND.
11.700	PRL8	RIO DE JANEIRO, BRAZIL.	11.948	—	MOSCOW, USSR; 9:15 to 9:30 pm.
11.705	SBP	STOCKHOLM, SWEDEN.	11.950	—	MEXICO CITY, MEXICO; heard evenings.
11.705	CBFY	VERCHERES, CANADA, 11 am to noon.	11.970	FZI	BRAZZAVILLE, FRENCH EQUATO-RIAL AFRICA.
11.71	VLG3	MELBOURNE, AUSTRALIA; 1:15 to 1:45 am.	11.975	—	RIO DE JANEIRO, BRAZIL; heard evenings.
11.710	WLWK	CINCINNATI, OHIO; European beam, 6:30 to 8 am.	11.98	—	LONDON, ENGLAND; 5:15 to 8 pm.
11.710	WLWO	CINCINNATI, OHIO; European beam, 2:45 to 5:15 pm.	11.995	—	LISBON, PORTUGAL; heard about 8:30 am.
11.718	CR78H	MARQUIS, MOZAMBIQUE.	12.000	—	SINGAPORE, STRAITS SETTLE-MENT.
11.720	CJRX	WINNIPEG, CANADA.	12.040	GRV	LONDON, ENGLAND.
11.720	PRL8	RIO DE JANEIRO, BRAZIL; 9:35 to 10:45 pm; off Sundays.	12.070	CSW	LISBON, PORTUGAL; 9:30 to 10 am.
11.725	JVW3	TOKYO, JAPAN; heard at 3:30 am.	12.095	—	LONDON, ENGLAND.
11.730	WRUL	BOSTON, MASS.; Mexican beam, 7:30 pm to 2 am; Caribbean beam, 6:15 to 7:15 pm; European beam, 2:45 to 6 pm.	12.110	H13X	TRUJILLO CITY; DOMINICAN RE-PUBLIC; late afternoons.
11.730	KGEX	SAN FRANCISCO, CALIF.; Ori-ental beam, 5:15 to 8 pm.	12.115	ZNR	ADEN, ARABIA.
11.730	WRUW	BOSTON, MASS.; European beam, 8 to 10 am.	12.120	—	BERLIN, GERMANY.
11.740	COCY	HAYANA, CUBA.	12.175	—	MOSCOW, USSR; heard 11:10 to 11:20 am; probably on at other times.
11.750	GSD	LONDON, ENGLAND; afternoons.	12.235	TFJ	ICELAND; Saturdays only, 10 to 10:30 pm.
11.760	DHE4B	PODIEBRAD, BOHEMIA; on at 6 pm; sign off time unknown.	12.265	—	MOSCOW, USSR; heard 11:10 to 11:20 am; probably on at other times.
11.77	DJD	BERLIN, GERMANY; evenings to North America.			
11.775	—	GENEVA, SWITZERLAND; 4 to 4:30 pm; 4:45 to 6 pm.			
11.775	—	SATGON, INDO-CHINA; 10 to 11:30 am.			
11.790	WRUA	BOSTON, MASS.; North African beam, 6 to 7:30 am; 7:45 am to 1:30 pm; 1:45 to 4:30 pm.			
11.79	KGEL	SAN FRANCISCO, CALIF.; South America beam, 5 pm to 12:45 am.			

(Continued on page 108)

**NEW EDITION
NOW READY**

Audels RADIOMANS GUIDE

Includes **TELEVISION
AND ELECTRONICS**

LARGER - MORE COMPLETE - 914 PAGES - 633 ILLUSTRATIONS - WIRING DIAGRAMS - PHOTOS

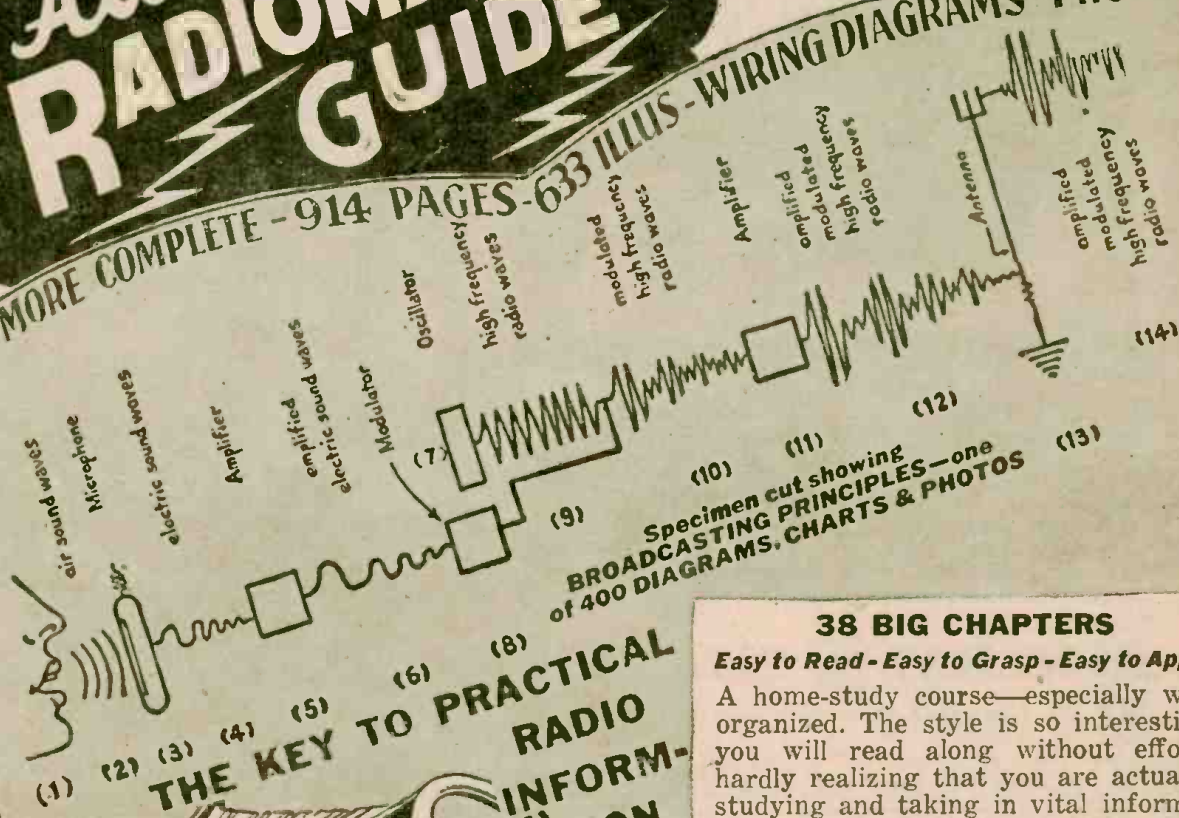

THE KEY TO PRACTICAL RADIO INFORMATION

Specimen cut showing BROADCASTING PRINCIPLES—one of 400 DIAGRAMS, CHARTS & PHOTOS

38 BIG CHAPTERS

Easy to Read - Easy to Grasp - Easy to Apply
A home-study course—especially well organized. The style is so interesting you will read along without effort, hardly realizing that you are actually studying and taking in vital information. Audels Radiomans Guide gives you just the right amount of mathematics required to cope with radio problems successfully. You can solve, with the aid of this extraordinary book, practically every radio problem that comes up. At your finger tips is a complete index for instant use.



**Q AND A
UNIQUE
QUESTION
and
ANSWER
METHOD**

Highly Endorsed

**1001 RADIO FACTS AND FIGURES
A Complete Library In One Book**

AUDELS RADIOMANS GUIDE gives authentic Principles and Practices in Construction, Operation, Service and Repairs. Covers clearly and concisely radio fundamentals—Ohm's Law—Physics of sound as related to radio science—Measuring instruments—Power supply—Resistors—Inductors—Condensers—Transformers and examples—Broadcasting stations—Radio Telephony—Receivers—Diagrams—Construction—Control Systems—Loudspeakers—Antennas—AutoRadio—Phonograph Pick-ups—Public Address Systems—Aircraft and Marine Radio—Radio Compass—Beacons—Automatic Radio Alarms—Short Wave—Coil Calculations—Testing—Cathode Ray Oscillographs—Static Eliminations—Trouble Pointers—Underwriter's standards—Units and tables. REVIEW QUESTIONS—READY Reference Index.

7 DAYS' FREE TRIAL

\$4 COMPLETE **\$1** PAY ONLY **1** MO.

THEO. AUDEL & CO., Publishers
49 West 23rd Street, New York 10, N. Y.

Mail AUDELS NEW RADIOMANS GUIDE for free examination. If O. K. I will send you \$1 in 7 days; then remit \$1 monthly until \$4 is paid. Otherwise I will return it.

Name
Address
Occupation
Reference

MAIL THIS COUPON TODAY



PORTABLE TUBE CHECKER

This portable G-E Tube Checker contains sockets for all American tube types . . . provides practically a complete service shop of tube analyzing equipment . . . equipped with the ingenious PMT Circuit Switch. This instrument is just one in the new General Electric line of SERVICE TESTING EQUIPMENT.

Among the other sturdy G-E units available for testing electronic circuits and component parts are: G-E unimeters, audio oscillators, oscilloscopes, condenser resistance bridges, signal generators and other utility test instruments.

GENERAL ELECTRIC

Electronic Measuring Instruments

177-C11

- 15.350 WRUL BOSTON, MASS.; North Africa beam, 10 am to 1:30 pm; European beam, 1:45 to 2:30 pm.
- 15.355 KWU SAN FRANCISCO, CALIF.; N. E. 1. beam, 7:45 to 9:30 pm; off on Wednesdays.
- 15.400 GRE LONDON, ENGLAND; heard in afternoon.
- 15.410 PZP PARAMARIBO, DUTCH GUIANA.
- 15.45 GRD LONDON, ENGLAND; heard at noon.
- 15.595 — "RADIO BRAZZAVILLE"; FRENCH EQUATORIAL AFRICA; 11:55 am to 12:55 pm.
- 15.620 VRR6 JAMAICA, BRITISH WEST INDIES.
- 15.750 — MOSCOW, USSR; heard mornings.
- 15.810 LSL3 BUENOS AIRES, ARGENTINA; heard mornings.
- 16.000 EPA TEHERAN, IRAN; operated by AFHQ.
- 16.025 AFHQ ALLIED HEADQUARTERS, NORTH AFRICA.
- 17.760 KWID SAN FRANCISCO, CALIF.; South America beam, 4 to 7:45 pm.
- 17.760 KWIX SAN FRANCISCO, CALIF.; South America beam, 11 am to 4 pm.
- 17.760 WRUW BOSTON, MASS.; Central America beam, 7:30 to 9:15 pm; European beam, 10:15 am to 2:30 pm.
- 17.760 KROJ LOS ANGELES, CALIF.; Australian beam, 9 to 11:45 pm.
- 17.773 OTC LEOPOLDVILLE, BELGIAN CONGO.
- 17.780 WRCA NEW YORK CITY; European beam, 10 am to 2:45 pm.
- 17.780 WNBI NEW YORK CITY; East South America beam, 5:30 to 6:45 pm; Sundays only, 5:30 to 7:30 pm.
- 17.800 WLWO CINCINNATI, OHIO; European beam, 8 am to 2:30 pm; West South America beam, 5:30 to 6:45 pm.
- 17.830 WCBN NEW YORK CITY; European beam, 7:30 am to 5:15 pm.
- 17.880 WGEX SCHENECTADY, NEW YORK; European beam, noon to 4:45 pm.
- 17.955 WLWLI CINCINNATI, OHIO; Central Africa beam, 10:45 am to 1:15 pm; 1:30 to 5:15 pm.
- 18.000 KRO2 HONOLULU, HAWAII; afternoons and evenings.
- 18.135 YDA BATAVIA, NETHERLANDS INDIES; 10 to 10:50 pm.
- 18.160 WNRA NEW YORK CITY; European beam, 10 am to 5:15 pm.

BROADCAST EQUIPMENT

(Continued from page 91)

WORLD WIDE STATION LIST (Continued from page 106)

- | | | | |
|--------------|---|--------------|--|
| 12.290 GBU | LONDON, ENGLAND. | 15.210 WBOS | BOSTON, MASS.; European beam; 7:45 am to 5:15 pm; East South America beam, 5:30 to 8:15 pm; "NATIONAL CONGRESS RADIO" (INDIA). |
| 12.445 HCJB | QUITO, ECUADOR. | 15.220 — | |
| 12.967 WKRD | NEW YORK CITY; North African beam, 6:15 to 9:30 am; 12:45 to 5:45 pm. | 15.225 JTL3 | TOKYO, JAPAN; 10:15 to 11:15 am. |
| 13.000 HDD | QUITO, ECUADOR; heard 3:45 to 4:30 pm. | 15.230 WLWLI | CINCINNATI, OHIO; North Africa beam, 6 to 9:45 am; 10 to 10:30 am; 10:45 am to 1:15 pm; 5:30 to 8 pm. |
| 13.085 COCH | HAWANA, CUBA. | 15.230 WKRX | NEW YORK CITY; Central Africa beam, 4:15 to 5 pm. |
| 13.22 ICA | ALLIED HEADQUARTERS IN ITALY. | 15.230 — | MOSCOW, USSR; off at 7:25 pm. |
| 14.56 HVJ | VATICAN CITY; 9 to 10 am. | 15.230 VLG6 | MELBOURNE, AUSTRALIA; on at 10 pm. |
| 15.000 WWV | WASHINGTON, D. C.; U. S. Bureau of Standards; days only. | 15.240 TPC5 | VICHY, FRANCE. |
| 15.11 DJL | BERLIN, GERMANY. | 15.250 WLWK | CINCINNATI, OHIO; European beam, 8:15 am to 5:15 pm; West South America beam, 5:30 to 8:15 pm. |
| 15.11 — | MOSCOW, USSR; 9:15 pm and 11:15 pm; 5:15 to 5:30 pm. | 15.260 GSI | LONDON, ENGLAND. |
| 15.120 DKSA | "SENDER ATLANTIK." | 15.270 HAS3 | "HUNGARIAN NATIONS RADIO"; 1 to 2 pm. |
| 15.130 DXR7 | BERLIN, GERMANY. | 15.270 WCBX | NEW YORK CITY; European beam, 7 am to 4:45 pm. |
| 15.13 KGEI | SAN FRANCISCO, CALIF.; Australian beam, 1 to 6:30 am. | 15.29 KWD | SAN FRANCISCO, CALIF.; Oriental beam, 2:45 to 3:15 am. |
| 15.130 WRUS | BOSTON, MASS.; North Africa beam, 1:45 to 4:30 pm; 4:45 to 6 pm; European beam, 7:45 am to 1:30 pm. | 15.290 KGEI | SAN FRANCISCO, CALIF.; South America beam, 5 pm to 12:45 am. |
| 15.130 DXL6 | BERLIN, GERMANY. | 15.290 KGEX | SAN FRANCISCO, CALIF.; South America beam, 11 am to 5 pm. |
| 15.140 G5F | LONDON, ENGLAND; 10 am to 4 pm. | 15.290 KWIX | SAN FRANCISCO, CALIF.; South America beam, 11 am to 1 pm. |
| 15.150 WNBI | NEW YORK CITY; European beam, 7:45 am to 3:30 pm. | 15.300 — | MANILA, PHILIPPINES; operated by the Japanese 11 pm to 1 am. |
| 15.150 WRCA | NEW YORK CITY; Brazilian beam, 5 to 7:45 pm. | 15.31 GSP | LONDON, ENGLAND. |
| 15.155 S8T | STOCKHOLM, SWEDEN; 7 to 7:55 am; 11 am to 2:15 pm; Sundays only, 4 to 11 am; noon to 2:15 pm. | 15.315 VLQ3 | SYDNEY, AUSTRALIA; 10:30 to 11 pm; 12:45 to 1:45 am. |
| 15.160 JZK | TOKYO, JAPAN; 9:15 pm to 12:15 am. | 15.325 JLP2 | TOKYO, JAPAN; 11:30 pm to 12:30 am. |
| 15.170 TGWA | GUATEMALA CITY, GUATEMALA; daytime transmissions. | 15.330 KGEX | SAN FRANCISCO, CALIF.; Oriental beam, 6:15 pm to 1 am. |
| 15.180 GSO | LONDON, ENGLAND; afternoons. | 15.33 MTCY | HSINGKING, MANCHUKUO; Japanese operated, 1 to 3 am. |
| 15.190 WOOC | NEW YORK CITY; European beam, 7:45 am to 5 pm. | 15.330 WGEO | SCHENECTADY, NEW YORK; European beam, 7 am to 9:15 am; 9:30 am to 3:30 pm; 3:45 to 5:15 pm. |
| 15.190 CBZ | MONTREAL, CANADA. | 15.350 WRUW | BOSTON, MASS.; Caribbean beam, 6:15 to 7:15 pm; European beam, 2:45 to 6 pm. |
| 15.190 KROJ | LOS ANGELES, CALIF.; Oriental beam, noon to 2:45 pm; 5 to 8:45 pm; Australian beam, 3 to 4:45 pm. | | |
| 15.200 WLWLI | CINCINNATI, OHIO; Central Africa beam, 6 to 9:45 am; 5:30 to 8 pm; South Africa beam, 10 to 10:30 am. | | |
| 15.20 DJB | BERLIN, GERMANY. | | |

actual line level by the value of the drop across the pad. Therefore, the meter is usually connected at the line end of the pad, and the results obtained by this method have been found to be satisfactory for most purposes.

SWITCHING APPARATUS

All the inputs and outputs of the component parts of the speech equipment are brought out to shorting-type jacks. This allows maximum flexibility and enables a program which has been interrupted due to equipment failure to be resumed with a minimum of delay. For example, if amplifier 3 of Fig. 1 should become defective, it may be bridged out of the circuit by inserting a patch cord into the output jack of amplifier 2 and into the input jack of amplifier 4, as shown. Likewise, stand-by equipment may be brought out to jacks, and substituted for faulty equipment when trouble occurs.

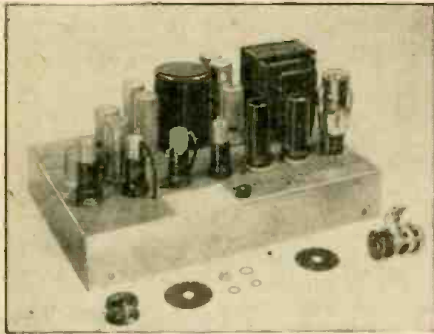

Standard RCA program monitoring amplifier.

All these equipment connections are brought out to a central jack panel, making long interconnecting leads unnecessary. In a short line, the lumped distributed capacitance is small enough to make the shorting effect negligible at the higher audio frequencies, and thus making equalization unnecessary.

MONITOR AMPLIFIER

When it was previously mentioned that separate speech equipment was used for monitoring purposes, the question may have arisen as to why a monitoring loud-speaker could not be connected directly across the studio amplifier or line amplifier outputs. This could be and sometimes is done, but for purposes of transmission a level of 0 db is required, while a level of at least +22 db is needed to properly drive the monitoring loud-speaker.

Then the main program amplifier must be designed to provide sufficient output to operate the loud-speaker satisfactorily, and its output is stepped down through an attenuation network to 0 db. However, separate amplifiers are desirable for monitoring purposes, as they transmit in one direction only, and serve to isolate the loud-speaker circuits from the line and to prevent any short- or open-circuit in them from affecting it. Use of an amplifier is more expensive, but adds to reliable and trouble-free operation—always very important items in the operation of a broadcast station.

This principle of using a vacuum-tube amplifier for purposes of isolation is seen very often in broadcast practice, as economy is entirely disregarded in favor of performance. The equipment is often so designed and installed that it may be connected through the jack panel, and substituted for a defective piece of regular program amplifier equipment. The RCA 82-C1 pictured above is a typical example of such apparatus.

(To be continued next month)

What will you need...

IN THE FIRST SIX POST-WAR MONTHS

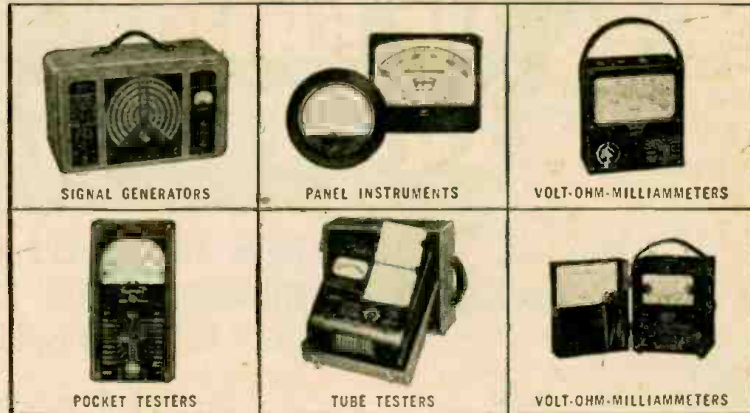

✓ CHECK THE TYPES AND QUANTITY

Estimate your future equipment needs and place a tentative post-war order for them with your jobber now. This foresight will enable him to stock the Triplet instruments you will need, and will assure you quicker resumption of civilian business. Give best priority you can obtain to facilitate deliveries as production is available.

Get the complete list of Triplet instruments and radio test equipment.



Triplet

ELECTRICAL INSTRUMENT CO. BLUFFTON, OHIO

HALLICRAFTERS ★ HALLICRAFTERS ★

RECEIVER HEADQUARTERS

for the Nation

BEFORE the war Bob Henry served the amateurs as the world's largest distributor of communications receivers.

Now Henry Radio is Hallicrafters receiver headquarters for the Nation at war. Hallicrafters Receivers can be supplied on AA-1 priority. I can usually supply SX-28s at \$223.00, SX-25s at \$94.50, and PM-23 speakers at \$15.00 at once. It takes longer to supply other models.

Soon, it is hoped, non-priority orders can be filled and Bob Henry can become again Hallicrafters headquarters for the nation at peace.

I have stores at Butler, Missouri, and at 2335 Westwood Blvd., Los Angeles 25, Calif.

Your orders and inquiries are invited.

Bob Henry, W9ARA

HENRY RADIO SHOPS

Butler, Mo. and Los Angeles, 25, Calif.

COMPLETE STOCKS

I have in stock NC-200s \$174.50 complete and some Hallicrafters receivers available for immediate delivery on priority and the following parts without priority: meter rectifiers \$1.95, transmitting tubes, transformers, resistors, condensers, panels, chassis, etc. Your orders and inquiries invited.

"WORLD'S LARGEST DISTRIBUTOR OF COMMUNICATIONS RECEIVERS"



REPAIR ANY KIND OF RADIO EQUIPMENT!

SEE MONEY-SAVING COMBINATION OFFER IN COUPON!

THE BOOK THAT HELPS YOU FIX TWO RADIOS IN THE TIME NORMALLY REQUIRED FOR ONE

Whether you repair radios for a living—whether you only tinker with them occasionally—or whether you simply want to fix your own radios and phonographs at home, Ghirardi's famous RADIO TROUBLESHOOTER'S HANDBOOK is one big book you can't afford to miss.

You don't have to study it. You simply refer to it when you want to learn how to repair a particular receiver model quickly or when you need specific information, substitution data, etc., on tubes and other components and dozens of other vital subjects. It tells exactly WHAT to do AND HOW. It eliminates the need for using costly test equipment all the time. It helps you repair Radios twice as fast—and repair them right!

This big 744-page manual-size book pays for itself in time saved the first time you use it. Now contains 404 pages of receiver Case Histories, giving common Trouble Symptoms, their causes and how to fix them, for over 4,000 receiver models. It gives specific data on practically every Radio now in common use.

How to "test" A RADIO in 2 Minutes!

Simply look up the Trouble Case History data for the set you want to repair. Nine times out of ten, the HANDBOOK will tell you just what is wrong, and EXACTLY how to fix it in a jiffy! No extensive testing! No guesswork! No lost motion! More sets fixed per day!

A. A. GHIRARDI
Radio's foremost authority and most widely read magazine and book author.



All this, however, is just the beginning of THE HANDBOOK'S usefulness. Other features include the most modern, most complete, and genuinely helpful Tube Chart you've ever seen, including complete substitution data. In addition, there are dozens of pages devoted to I-F alignment peaks for over 20,000 superhets; I-F transformer troubles; and hundreds of tables, graphs, charts, and data compilations of all kinds designed to quickly give you every type of servicing help WHEN YOU NEED IT.

This big 744-page book is yours COMPLETE for only \$5 (\$5.50 foreign)—and it comes to you on a 5-DAY MONEY-BACK GUARANTEE BASIS. You can't lose!

THE BOOK THAT GIVES YOU BASIC SERVICE WORK TRAINING

Ghirardi's Famous "Modern Radio Servicing"

Here's another popular Ghirardi volume without which no radio library is complete—MODERN RADIO SERVICING. It shows how to substitute scientific servicing methods for guessing, yet is written so clearly that you can easily understand it without an instructor. It is the only single, inexpensive book giving a complete course in radio service work, including a thorough explanation of all Test Instruments, exactly how they should be used AND WHY; Receiver Troubleshooting Procedure; Circuit Analysis, Testkit and Repair of Parts; Installation; Adjustments, etc.—also How to Start a Successful Service Business. In short, it gives you a thorough, practical training in Radio-Electronics servicing—at home. In spare time. 706 clear illustrations; 720 review questions; 769 different topics. \$5 COMPLETE (\$5.50 foreign). 5-Day Money-back Guarantee!

Here's A Hot Christmas Gift Tip!



There's no finer Christmas gift than Ghirardi's Radio-Electronic books—especially in times like these. Your radio-inclined friends will appreciate them more than anything you might give. And here's a tip: Maybe you'd like someone to give these big books to you! If so, why not give this coupon TODAY to friends or relatives who are probably wondering what in the world you'd like? They'll appreciate the hint—and you'll appreciate the books!

5-DAY MONEY-BACK GUARANTEE

RADIO & TECHNICAL DIVISION, Murray Hill Books, Inc., Dept. RC-114, 232 Madison Ave., New York 16, N. Y.

Enclosed find \$..... for books checked (send postpaid); or send C.O.D. (in U.S.A. only) for this amount plus postage. If I am not fully satisfied, I may return the books within 5 days and receive my money back.

MONEY-SAVING COMBINATION OFFER—Both of the above big books for only \$9.50 for the two (\$10.50 foreign)

Ghirardi's RADIO TROUBLE SHOOTER'S HANDBOOK, \$5 (\$5.50 foreign)

Ghirardi's MODERN RADIO SERVICING \$5 (\$5.50 foreign)

Name

Address

City & Dist. No. State

The books that tell you **WHAT** to do **HOW** to do it

RECORD CHANGERS

(Continued from page 93)

exactly where the grooves start. The vertical motion is synchronized so as to lower the pickup to the record at this moment.

C. Simultaneously with the foregoing action, the pickup is freed of its mechanical association with the cam and allowed to move freely across the record until it engages with a lever at the finish of the record and thereby starts the changing cycle all over again.

Synchronism can be obtained perfectly due to the fact that all mechanical movements are produced from the same cam wheel.

THE REPEATING MECHANISM

In older model phonographs the turntable motor was stopped at the end of a record, or the repeat cycle started, when the pickup arm struck a level which was placed in such a position that the arm would have reached the last groove of the record before encountering it. Since it is impossible to make every record with exactly the same playing time, the phonographs using this device would often cut off before the end of a selection—or else fail to work because the pickup would not play in far enough to touch the lever.

Several ingenious mechanisms have been devised which actually seem to tell when the record has finished playing regardless of whether its grooves go as far toward the center as possible or run only for a few inches.

To provide for such a system, all present day commercial recordings are manufactured with an eccentric groove around the center. The needle is led into this as soon as it leaves the last groove of the recording. The pickup, in following this groove, must make a back and forth motion in the horizontal direction. This motion is the "signal," figuratively speaking, for the repeat cycle to start.

Two typically representative methods of translating this "signal" are described.

1. Solenoid Method

The pickup arm is mechanically connected to a lever upon which is fastened a pair of leaf spring "fingers." These "fingers" press against a smooth plate upon which they slide forward simultaneously with the movement of the pickup as it follows the groove inward to the center of the record. See Fig. 3.

As long as the pickup arm continues to move toward the center, the "fingers" will slide on the face of the plate since it rests against a stop and cannot be pushed away. But if the pickup arm should be impelled in the opposite direction the "fingers" hold on to the plate and pull it back also. This sudden reversed motion is employed to trip a switch which operates a solenoid to lock in the "change cycle" cam wheel and start the changing operation.

By means of the diagrams it can be seen that as long as the pickup moves slowly to the left, as it would if playing a record, the contacts will not come together, but the "fingers" will slide along the face of x. But a quick motion to the right pulls out x and closes the switch. This is what happens when the pickup needle engages the eccentric groove causing it to move back and forth. Obviously, lifting the pickup by hand will also set off the repeat solenoid.

2. Mechanical Method

This system, instead of responding to a reverse motion of the pickup, responds to a

quick motion in the same direction in which the pickup is already moving. The pickup arm can, therefore, be lifted from the record by hand without danger of damage from forcing due to its suddenly going into a change cycle while, at the same time, it is being held.

In the case of a mechanical repeat mechanism, a lever is held to the shaft of the pickup arm by means of a friction coupling. Therefore, this lever advances toward the "trigger" at the same rate that the pickup moves across the record. When the lever (known as the "tripping pawl") reaches the trigger, or "tripping finger," it will trip the mechanism to lock in the cam wheel. However; each time the tripping lever advances the width of one groove (approximately .01 inch) it is pushed back by the face of the trigger. See Fig. 4. As long as the lever moves only .01 inch during each revolution it will never engage the trigger; instead, it will be "trimmed" back to its original position every time. But if it should suddenly move forward a quarter inch during one revolution, as it does when the eccentric groove is encountered, it will clear the lip of the trigger and engage it fully.

Fig. 4A shows the rotating cam approaching by .01 inch the trigger. Obviously, the trigger will be pushed away instead of engaging it. In B, the tripping pawl has moved downward suddenly, throwing the trigger face out to the right so that it now engages the rotating cam.

Fig. C. The change cycle cam is now rotating and will continue to rotate until the trigger is disengaged by a stop.

In some cases, after the trigger has traveled around one revolution, it meets a "hump" which disengages it. See Fig. 5. A.

The trigger approaches the hump.

B. It is pushed downward by the hump, breaking loose its grip on the cam wheel and ending the operation.

The starting trigger itself may appear in many forms, only one of which was described above. The serviceman must study the method used in each of the types of changers brought into the shop. Another much used version of the starting trigger (or "tripping finger") is used on a geared cam wheel with a missing tooth on one side as in Fig. 6.

The small gear rotates continuously but, since a tooth is missing, it will not engage the large gear. When the trigger is activated a retracting tooth is pushed out engaging with the teeth of the small gear and starting the revolution. The trigger falls back, retracting the temporary tooth so that when one revolution is completed the gears will again disengage and end the cycle.

The second half of this article will appear next month. It deals with record selecting mechanisms.

Photoelectric cells are now used on the smoke-detecting apparatus installed aboard ships. The apparatus consists of a series of pipes connected to 30 different parts of the ship, whose ends are brought out in a cabinet in the wheelhouse. The officer on watch is supposed to keep an eye on the cabinet and note whether smoke comes from any of the pipes.

Substitution of the electric eye assures instant detection. The apparatus is so constructed that one pipe is examined at a time, and the device not only gives an alarm, but indicates the compartment in which the fire has broken out.

Who said it costs a lot of money to LEARN RADIO-ELECTRONICS?



Here's a CHRISTMAS GIFT TIP For You!

Someone is wondering what in the world to get you for Christmas! Why not help them out—and give yourself a big boost in the bargain! Why not drop a Ghirardi's you'd like A. A. Ghirardi's RADIO PHYSICS COURSE and give them this coupon to mail? They'd appreciate it—and especially because there's no finer gift at any time than one that will prepare you for a SUCCESSFUL FUTURE WITH MORE MONEY!

THE MOST WIDELY USED RADIO-ELECTRONIC TRAINING BOOK IN THE WORLD

No sir! Radio-Electronic Training doesn't have to be expensive. The amazing fact is that A. A. Ghirardi's famous 972-page RADIO PHYSICS COURSE gives you just the training you need—ALL YOU NEED—easier, better, faster—AT A TOTAL COST OF ONLY \$5 COMPLETE. Proof? It's a matter of record that RADIO PHYSICS COURSE is more widely used for home study, by more civilian schools and colleges, and more universally employed in Signal Corps and Navy Schools than any other book of its kind. As proved by an actual survey, 9 out of 10 radio men themselves endorse it as the finest, easiest-to-understand Radio-Electronic training course on the market.

MAKE MORE MONEY IN A BETTER POST-WAR JOB

No previous knowledge of Radio-Electronics is necessary when you use Ghirardi's RADIO PHYSICS COURSE. For it carries you rapidly from Basic Electricity (over 300 pages) to the latest, most modern developments. Nothing is omitted. Nothing is condensed. Every step is made crystal clear by simplified, thorough explanations and by more than 500 clear, specially prepared illustrations. Each section is followed by Self-Testing Review questions, so you can check your progress every step of the way! There are no monthly lessons to wait for. You go ahead as fast as you want to. All you need is a little spare reading time plus a desire to get started NOW to make more money in a better, more interesting future in broadcasting, aviation radio, F.M. television, radio servicing, electronic manufacturing—or any other of Radio-Electronics' fast growing branches.

Send the coupon today!

MAIL THIS COUPON NOW!

RADIO & TECHNICAL DIVISION, Murray Hill Books, Inc. Dept. RC-114, 232 Madison Ave., New York 16, N. Y.

Enclosed find \$5 (\$5.50 foreign) for A. A. Ghirardi's 972-page RADIO PHYSICS COURSE book; or send C.O.D. (in U.S.A. only) for this amount plus postage. In either event, it is understood that I may return the book in 5 days for refund if not satisfactory.

Name

Address

City & Dist. No. State

YOUR MONEY BACK!

Send coupon today! Compare Ghirardi's RADIO PHYSICS COURSE with any other Radio book or course AT ANY PRICE. Use it for 5 days. Then, if you are not more than satisfied that it will teach you basic Radio-Electronics EASIER, FASTER, and at LESS COST, return it. We will refund your money WITHOUT QUESTION!

36 COURSES IN ONE!

Actually, RADIO PHYSICS COURSE gives you the scope of 36 complete courses in one big book. If it were broken into sections and sold as a series of lessons, you'd regard it as a bargain at \$50 or more. It's yours, however, in this handy 1-volume form for only \$5 COMPLETE (\$5.50 foreign)—and you don't even take the slightest chance on that amount.

Learn at home—EASIER, BETTER, FASTER

FASHION NOTES

SYLVANIA SERVICEMAN SERVICE



by
FRANK FAX

**SAVE YOUR SUITS — WEAR
SYLVANIA WORK CLOTHES**

This service coat is a knee-length, double strength herringbone-weave dungaree. Roomy pockets at arm's length. Can be buttoned far down the front to protect street clothes. Available in sizes 36, 38, 40, 42 and 44. Price each: \$1.95.



This service apron, made of heavy green duck, has three tools-and-parts pockets. Just the thing to impress customers with your efficiency and nearness. Buy several, so you'll always have a clean one. Price: only 25 cents

This service jacket is made of the same tough material as the service coat. Single-breasted, three large pockets, full-length sleeves. Just as suitable for shop wear as service calls. Available in sizes 36, 38, 40, 42 and 44. Price: \$1.75



Order from your Sylvania Jobber or direct from Frank Fax, Department RC-11, Sylvania Electric Products Inc., Emporium, Pa.

SYLVANIA ELECTRIC PRODUCTS INC.
RADIO DIVISION

Progress in Invention

Conducted by I. QUEEN

PENTODE-SYNCHRONIZED MECHANICAL VIBRATOR

Patent No. 2,349,125

THIS device uses only a single pentode type tube to provide an extremely accurate, simple and rugged vibrator system. The vibrator coil in the output circuit of the pentode is tuned by a .005 condenser to its resonant frequency.

Reed and electrode (1) form a varying capacitance in the input circuit. Note the 20 megohm resistor between control grid and ground to protect against possible shorting of the reed (highly positive) and the electrode (highly negative). Initial movement of the reed at the vibrator resonant frequency applies an input potential

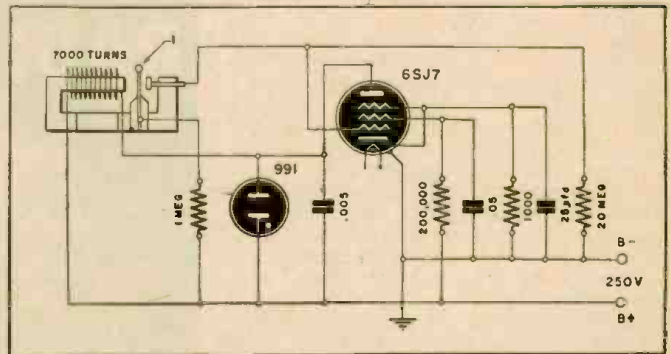

to the 6SJ7, its output being fed back to the vibrator coil. An extremely stable oscillation results.

GALVANOMETER WITH FEEDBACK

Patent No. 2,351,353

THE advantages of feedback in audio amplifiers are well known. Chief of these are better frequency response and decreased distortion. Application of feedback to a galvanometer also has its advantages, according to a patent just issued to Malcolm D. McCarty of Dallas, Texas. He claims better response and damping control.

The feedback is obtained by mounting an additional coil on the same support as the usual galvanometer coil. While the regular coil acts as the motor which moves the pointer across the dial to the indicated spot, the other acts as a generator, the motion in a magnetic field setting up a voltage across its terminals. Its output may be applied to a load for damping control, or to an inverse feed-back circuit.

The principle, when used as a damping control, is that of the well-known dynamic brake. Output terminals of the inner coil shown in Fig. 1 may be shorted, or a low resistance placed across them. Fig. 2 indicates the response improvement when the output is applied to a feed-back circuit.

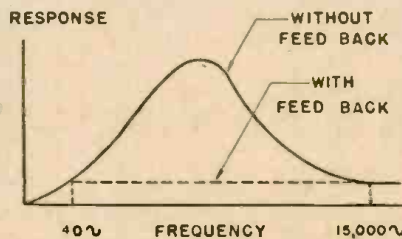
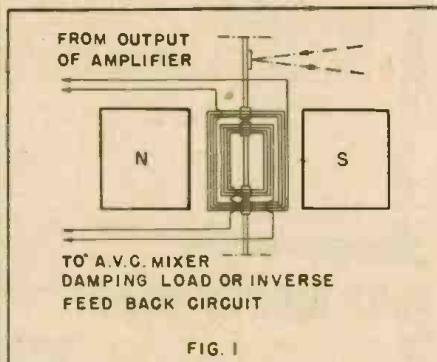

FIG. 2

IMPROVED PUSH-PULL CIRCUIT

Patent No. 2,350,858

IN many circuits which use fixed bias, hum from the power supply becomes a problem. An improved arrangement to minimize such hum, patented by Joseph A. Worcester, Jr., of Fairfield, Conn., is shown here.

The bias voltage (across resistance 1) is filtered by 2 and 3. The A.F. input is amplified by V1, and V2 is the phase inverter. Any hum at the V3 and V4 grids from the bias supply will cancel, due to the push-pull action of the tubes. But hum at the V3 grid may be amplified through the phase-changer, V2. By making the ratio of the resistances 4 plus 5 to resistance 5 equal the amplification factor of V2, hum from the bias supply introduced to the V4 grid through the phase-changer is equal in strength and opposite in phase to that introduced directly, thus cancelling out, leaving only the hum present at the V3 grid.

The inventor claims a notable saving in filtering apparatus and a substantial reduction in hum.

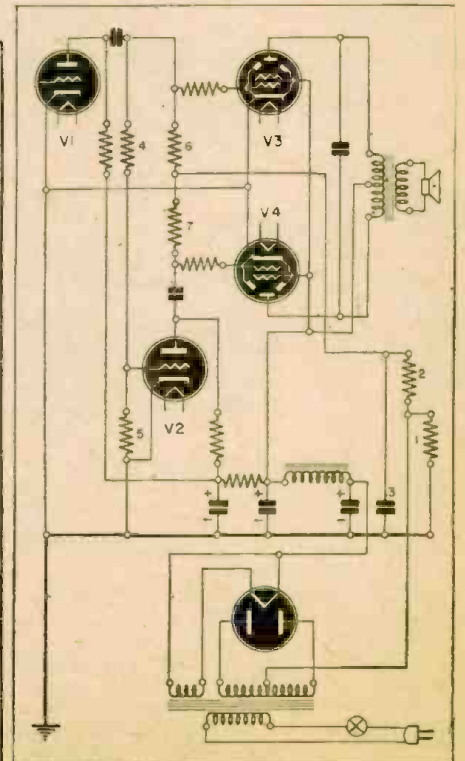

It worked! That is, she had to admit, if one didn't mind the distortion and lack of volume and grid hum. Yes, it worked all right—something awful!

Shutting off the Edison, Sally disconnected the crystal pickup, then resumed hunting through her service manuals. The only data she could find was for later radio receivers. Why, oh, why had she promised to install a crystal pickup? Why hadn't she purchased a new magnetic pickup, and let well enough alone? No, she had to be smart! Sally Mason and her bright ideas!

Well, what must be done, must be done! She was licked, and she knew it. The ancient circuits were worse than the most complicated brand new ones. If only the Edison had AVC, or something! She hated to do it, but she had to ask Technical Corporal Dan Bryner's help—again!

He came right over, a surprised look on his tanned face. But he said nothing, except: "Good morning, Sally. What's worrying you today?"

Sally shook her head. "I'm supposed to install a crystal pickup in Mrs. Cartwright's Edison. I've tried. But I just haven't had any luck. Oh, I've had luck—all bad!"

She showed Dan the drawings she'd made, the bright ideas she'd tried. "I see," he said after a long silence. "I see. FIG. 3 shouldn't have had all that hum—the pickup cable is shielded. Hey—did you ground the shield, or did you connect it to the detector grid?"

Sally waved her hands. "Why ask me? All I have is bright ideas—which never work!"

Dan borrowed a pencil and a sheet of paper. A few minutes later he showed her the diagram he'd drawn. "FIG. 4 is what we need," said Dan. "Any double pole, double throw switches? Rotary, or toggle switch will do."

Sally brought him two switches. "Take your choice. I have one of each; one rotary, one toggle switch."

"Better use the rotary switch," said Dan, "with a pointer knob and a PHONO-RADIO nameplate. Looks better. We can mount the switch in the hole we made for the other PHONO-RADIO switch. Is everything in FIG. 4 clear to you? After all, understanding the theory involved in this job will help you when similar jobs come along. They will, sooner or later."

Sally studied the diagram, wrinkled her nose several times, then said: "We've got shielded wire—even a few feet of coaxial cable, for the short grid leads. Want 'em?"

Dan shook his head. "We may not need shielded cable. If we do, we can replace the ordinary insulated wire, later. But the diagram, FIG. 4—is everything clear to you?"

"Y-e-s," said Sally, hesitantly. "I can see that the detector grid goes to its original circuit when the PHONO-RADIO switch is on RADIO, and the cathode is grounded. That's just as it was originally. But why the electrolytic condenser and resistor R?"

"Because the detector tube is not a detector when we switch to PHONO," said Dan, grinning. "As this isn't a superhet, it can't be I.F. It isn't a detector. So, what can it be? Doesn't the electrolytic condenser give you a hint?"

Sally sadly shook her head. "Today," she said. "I am dumber than usual. Much!"

"Guess."

"Audio! Nothing else is left. Or is there?"

Dan laughed. "Right! The detector tube becomes an audio frequency tube, on PHONO. Now—what's the value in ohms of cathode resistor R?"

After some thought and more nose wrinkling, Sally said: "Now lemme see. Audio. I know—the same as the cathode resistor in the first audio stage! Right?"

"And I was going to calculate the value!" said Dan. "Although the plate voltage is lower on the detector than on the first audio tube, the same value should be okay. Let's try it. And where's that half megohm volume control?"

The job took very little time. "Now let's try it," said Dan. "I may have left off a lead—or maybe we'll have to use shielded, or coaxial cable. We'll know . . . soon."

The tubes heated to operating temperature and Dan switched to RADIO, tuned in several stations, then nodded his head.

Then he switched to PHONO and played a record.

"Wonderful!" said Sally. "More volume and much better tone quality than I'd dared hope for! Thanks a million, Dan."

"It's okay," said Dan. "I enjoy working on radios—maybe that will help me remember the little I've learned." He started for the door. "Well, so long, until next time."

Sally, standing in the door of her shop, watched him swing with a military stride down the dust-covered road. "If he can only dance," she mused, "as well as he can fix radios . . ."

Sally turned back to her bench, humming a little tune as she started to work on an intermittent Emerson.

PORTABLE POWER PROBLEMS

THIS MONTH—VULTEE FLIGHT RECORDER

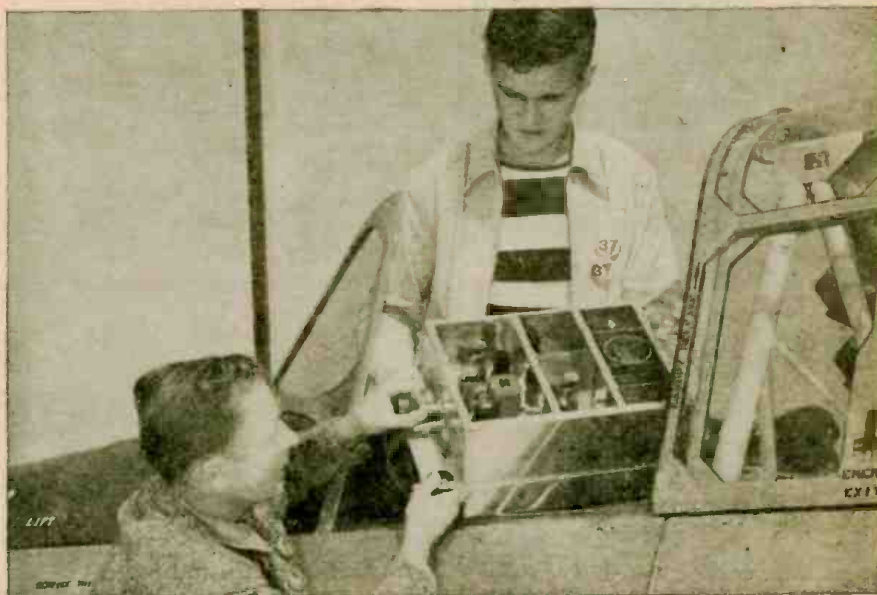

THE RADIO FLIGHT RECORDER accurately supplements test-pilot observations on performances of new planes. From a 70-point system of gauges, vibration, strain and engine performance readings are flashed to the ground receiver. When this amazing device was developed by Consolidated Vultee, the required compact, reliable portable power was supplied by Burgess Batteries, also used in all laboratory testing and development work at Vultee Field.

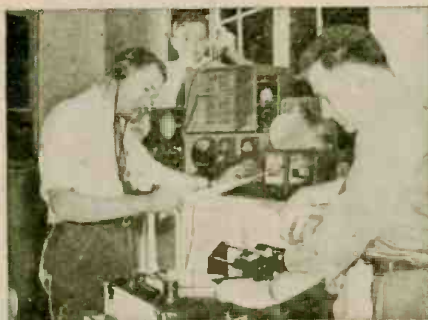

AT THE GROUND STATION, a Burgess-powered receiver records all data on ticker tape, sound film and disks. Analysis of film and disks permits engineers accurately to determine the planes' performance under varied conditions. New, special purpose batteries are constantly being developed by Burgess engineers.

Let them solve your portable power problems. Free 80-page Engineering Manual, 25 charts, 36 data tables and 31 descriptive pages on characteristics of dry batteries. Tabbed for ready reference. Write Dept. C-3 for free copy. Burgess Battery Co., Freeport, Ill.

BURGESS BATTERIES

LARGEST STOCKS CENTRALIZED SERVICE

FREE
Complete
Up-to-date
BUYING
GUIDE

Everything
in **RADIO and**
ELECTRONICS



REPAIR and
REPLACEMENT
PARTS
AVAILABLE
without priority

SAVE TIME
CALL ALLIED FIRST!

Thousands use
Allied's nation-wide
service. Centralized

here are today's largest and most complete stocks under one roof. Over 10,000 items from all leading manufacturers . . . for the Armed Forces, Radio Training, Laboratories, Industry and Service Replacements. Our experienced staff simplifies procurement—expedites delivery. Call **ALLIED** first . . . for everything!

Write, Wire, or Phone Haymarket 6800

6 Radio Books for 75c

Dictionary of Radio Terms. No. 37-751 **10c** Radio Data Handbook. No. 37-754 **25c**

Radio Circuit Handbook. No. 37-753 **10c** Radio Builders Handbook. No. 37-750 **10c**

Radio Formulas & Data Book. No. 37-752 **10c** Simplified Radio Servicing. No. 37-755 **10c**

All Six Books No. 37-799 . . . **75c**

Write for Quantity Prices



ALLIED RADIO CORP., Dept. 2-L-4
833 W. Jackson Blvd., Chicago, Ill.

Please send following books (.....c enclosed)

- FREE 37-750 37-752 37-754
 Buying 37-751 37-753 37-755
 Guide No. 37-799 (All Six Books)

Name.....

Address.....

City..... State.....

ALLIED RADIO

SPEECH AMPLIFIERS (Continued from page 88)

across the output side of the figure. This value, C_c , is the resultant capacitance formed from C_p and C_g . The reactance of C_c at high frequencies is low enough to reduce the effective value of R_1 , and therefore reduce the voltage developed at the output. This figure, Fig. 4-c, shows the circuit as seen by the high frequency signal when looking toward the grid of the following stage.

To calculate the degree of amplification at high frequencies, it is necessary to consider the shunting effect of C_c and all calculations will be made by comparison with the gain for the intermediate frequencies. The equation for this calculation is:

Gain at high frequencies

Gain at intermediate freq.

$$= \frac{1}{\sqrt{1 + (R_{eq}/X_{cc})^2}}$$

where

R_{eq} = equivalent resistance formed by plate resistance, plate load resistance, and grid resistance in parallel.

$$= \frac{1}{R_{eq}} = \frac{1}{R_p} + \frac{1}{R_1} + \frac{1}{R_g}$$

X_{cc} = reactance of total shunting capacitance, C_c .

$$= \frac{1}{6.2832 \times f \times C_c}$$

when

f = frequency in cycles

C_c = shunting capacitance in FARADS

From these equations it is evident that the falling off of the high frequencies is due to the presence of the shunting capacitance and the extent of the drop in amplification level is always determined by the ratio of shunt reactance of the shunting capacitance to the equivalent resistance. The extent of the decrease in gain at high frequencies is emphasized by the fact that when the gain has fallen 29.3 percent from its value at intermediate frequencies, the reactance of C_c is then equal

to the resistance formed by R_p , R_1 and R_g in parallel.

The coupling network, as seen by low frequencies, reveals, Fig. 4-d, that the shunting capacitances do not enter into the calculations but the coupling condenser, C_c , has quite a bit to say about the frequency response curve. The reactance of this condenser at low frequencies becomes so large that this value will be effectively in series with the value of R_g and the consequent combination will form a voltage divider with the grid of the following stage connected at the tap between the reactance and grid resistor.

All calculations of low-frequency gain must be made with reference to the gain at intermediate frequencies. The following equation applies for these calculations.

Gain at low frequencies

Gain at intermediate frequencies

$$= \frac{1}{\sqrt{1 + (X_{cc}/R)^2}}$$

where

$$X_{cc} = \frac{1}{6.2832 \times f \times C_c}$$

= reactance of coupling condenser
and

$$R = \frac{R_1 \times R_p}{R_1 + R_p}$$

= resistance formed by the combination of the grid resistor in series with the plate and load resistances in parallel.

when

f = frequency in cycles

C_c = capacitance of coupling condenser in FARADS.

The observations formed from this equation may be stated as follows: "The degree to which the signal falls off at low frequencies is dictated by the ratio of the reactance of the coupling condenser to the resistance formed by the combination of plate resistance, plate load resistance and the grid leak resistance, all in parallel."

"SWEATER GIRLS" ARE REALLY IN DEMAND AT THIS PLANT

"Sweater girls" are welcomed in at least one branch of war industry. The lassie checking set operation in simulated stratosphere temperatures of 65 degrees below zero finds her sweater very useful indeed. The photograph was taken in the Inspection Department of the Bendix Radio plant at Baltimore, and the radios are destined for our high-ceiling aircraft.

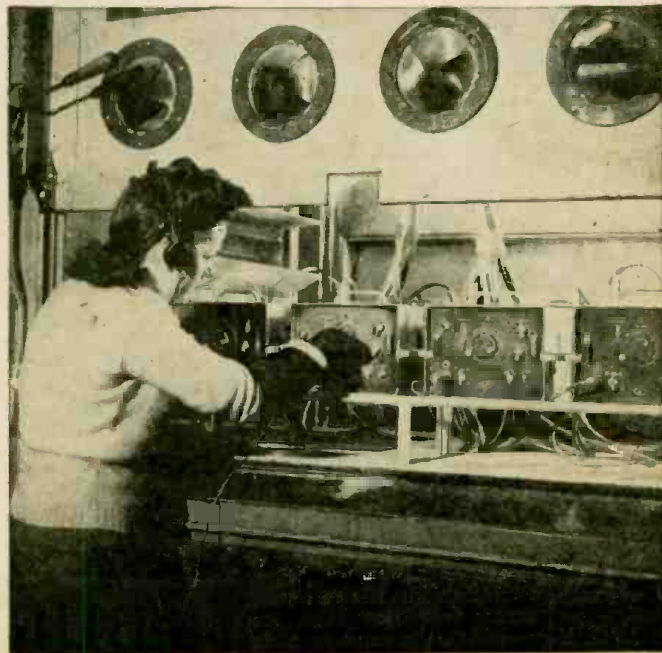

TECHNOTES

Do you have any Servicing Notes available which you would like to bring to the attention of the readers of *Radio-Craft*? If so, send them along and earn a one year's subscription to *Radio-Craft* for each one submitted.

... PONTIAC AUTO RADIO 983507

Excessive fading, cutting in and out, noise, especially on rough road.

One speaker field end is grounded to speaker chassis. Both speaker and receiver are grounded to case through mounting screws. Cardboard ring between speaker and case compresses causing loose mounting screws, resulting in intermittent speaker field current. A ground wire soldered from speaker to receiver chassis eliminated this trouble.

... GENERAL ELECTRIC LB 620

Body capacity howl or hum when tuning set or adjusting volume. A by-pass condenser, .01 to .1 from metal grill forming front of cabinet to receiver chassis will eliminate this trouble. Chassis is above ground potential, therefore do not connect grill directly to chassis.

... ADMIRAL RADIO-PHONO MODELS

Some of these sets have ungrounded phono motors, resulting in hum when records are played. Ground the motor frame to receiver chassis.

MALCOM E. HUGHES,
New Orleans, La.

... SEMI-BLOWN 35Z5'S

Reference to your article "SERVICE NOTE ON 35Z5's," page 249, January issue of *RADIO-CRAFT* I note that you suggest connecting an additional .15-amp. pilot lamp between prongs 2 and 3. Several months ago I hit upon this idea. However, the theory didn't work out so well for me in practice. The current flowing through the filament of the 35Z5 and associated tubes is .15 amp. and, hence, the two .15-amp. pilot lamps in parallel should each pass .075 amp. or one-half the rated load. This would appear to be safe, but the theory failed to take into consideration the initial surge voltage when the set is switched on.

I burned out several new .15-amp. pilot lamps before discarding this method for the easiest repair of connecting a 20- to 25-ohm resistor between prongs 2 and 3. Too much resistance between these prongs will also cause the pilot lamp to burn out under the momentary surge voltage when the set is switched on.

It may be of interest also to note that when I make a repair of this nature I record it with other pertinent information in my files. The customer is cautioned that it is only an emergency repair and that he will be advised to return the set for a removal of the resistor as soon as a new 35Z5 tube is available. When new tubes are available I drop a card to the customers whose sets I have thus repaired and request that they bring the radio in for correction.

M. S. WARREN,
Williams, S. C.

... SILVERTONE 620

If this set cuts out at the slightest change in line voltage, replace the 75-ohm 1-watt resistor, (R-13 on schematic) with a 50-ohm, 1 watt.

This increases the voltage on the 50Y6 rectifier plate.

Some models came out with this modification.

C. R. COOK,
Kearney, Neb.

LAST CALL!

LIMITED NUMBER OF CATALOGS AVAILABLE!

Write for your copy NOW!

- You can get those sorely needed parts and supplies more rapidly from "RESCO" . . . As one of America's largest distributors we carry ample stocks of the products of RCA, National Union, Cornell-Dubilier, IRC, Stanco, Sprague, Weston, Aerovox, Bogan, Ohmite, Triplett, Burgess, Clarostat, Shure, Hallicrafters, Thordarson, Raytheon, Amperex, and dozens of other famous makes of Radio-Electronic and Electrical Products.

- That's why you should immediately get a copy of our large catalog—of which the supply is very limited. Deliveries? Yes, we can make 'em! Because of our ample inventories and rolling stocks, and because of our strategically located branches, we can make amazingly rapid shipments.
- Get our catalog. Find the items you need—then 'phone or wire our nearest branch. You'll get prompt and complete satisfaction.



RADIO ELECTRIC SERVICE CO.

Main Store: N. W. Cor. 7th & Arch Sts., Philadelphia, Pa.

— BRANCHES —
PHILADELPHIA:
3145 N. Broad St., 5135 Market St.
ALLENTOWN, PA.:
1042 Hamilton St.
CAMDEN, N. J.:
513 Cooper St.
WILMINGTON, DEL.:
219 W. 8th St.

SMART IDEA:

Though we're all absorbed in vital war work, let's give some thought to the future. Do a smart thing now — get thoroughly acquainted with Insuline's vast line of Radio-Electronic Products and the Insuline Manufacturing Facilities . . . These 2 books tell the story. Write for them now.

48-page Catalogue describes Insuline's vast line of Radio-Electronic Products.

8-page Brochure presents Insuline's organization and manufacturing facilities.

What are your requirements? Send data for immediate assistance.

INSULINE

CORPORATION OF AMERICA

INSULINE BUILDING · LONG ISLAND CITY, N. Y.

MAINTENANCE and SERVICING of ELECTRICAL INSTRUMENTS

By
JAMES SPENCER

In charge of Instrument and Relay Department,
Meter Division, Westinghouse Electric & Manu-
facturing Co., Newark, N. J.

Reprints Available

This reprint should be of great value to all those whose problem it is to keep in operation the electrical instruments on vital war production as well as those on planes, signal equipment, tanks, ships, guns and other armament.

The electrical instrument industry has expanded more than 30 times its normal production, but its service facilities in general have not kept up with this pace. Some electrical instrument manufacturers do practically no servicing and cannot promise early return of the few instruments they accept for repairs.

This reprint should be useful to all instrument users, switch-board attendants, testing engineers, and instrument service men, as the accuracy and efficient life of instruments depend to a large extent on competent handling.

Durable fabri-kold binding, 256 pages,
5 x 8 1/2 inches, 274 illustrations.
Price \$2.00 postpaid.

**CHECK, MONEY ORDER
OR CASH MUST ACCOM-
PANY ORDER.**

INSTRUMENTS PUBLISHING COMPANY
1130 Woffendale St., Pittsburgh 12, Pa.

Enclosed is \$..... to cover the cost (\$2.00 each) of.....copies of SPENCER—MAIN-
TENANCE AND SERVICING OF ELECTRICAL
INSTRUMENTS.

Name

Address

City

ELECTRONICS AND AIR POWER (Continued from page 81)

children in the use of fire-arms, in military tactics and guerilla warfare. Many jeered at their 5-year plans and their so-called Finnish campaign.

Today no one laughs at the Reds, least of all the Nazi who too late has discovered that he has been baited into a disastrous attack by one of the greatest military hoaxes ever engineered in the Finnish "fiasco." He has found himself outdone at his own game of the well-known double-cross, and then out-smarted, out-manoeuvred, out-fought and finally driven before a ceaseless, crushing, tearing, "meat-grinder" offense toward inevitable military disaster.

Today an apprehensive world wonders at the shadowy Colossus who grinds his relentless and bloody way through the Eastern gates of Europe. Where will he call a halt? What is his intent? What lies hidden behind the mountain fastness of his snow-clad Urals?

Largest in area and population, richest in natural resources, most ably led and with peoples welded together in the fires of conflict, a new and mighty and wholly unpredictable nation has thrust itself upon a wondering world.

Prediction 4—World War II Will Solve The Basic Problems Of Stratospheric And Interstellar Flight.

Another angle overlooked by commentators during this war is the fact that under the pressure of desperate war necessity, devices and principles have been evolved which have already solved most of the problems of stratospheric and interstellar flight and brought them within the realm of practical reality. This is particularly true of the required electronics devices.

The remarkably successful application of the rocket and jet-propulsion principle to projectile and plane propulsion has brought fantasy into the possibility classification. Giant stratosliners with retractable wings may start off as jet-propelled planes, climb to tremendous heights, circle the globe once or twice, accelerate to terrific speeds in increasingly wider spirals, gradually retract their wings as they spiral out of the Earth's stratospheric belts and then shift into rocket propulsion and head out into interstellar space at steadily increasing velocities to

near-by Solar System bodies or interstellar relay-stations.

The problem of maintaining life in stratospheric or interstellar space during inspection or repair details or in meteorite-damaged compartments has been solved by the equipment developed for stratospheric fighter and bomber plane pilots.

Oxygen helmets and heavy electrically-heated suits would enable technicians to emerge from dual-lock hatches similar to those used in submarines to move about on cat-walks and hand-rails outside the stratospheric ship to make their inspection rounds and repairs. The goggles would have to be anti-glare types with filtering characteristics for harmful high-frequency solar radiations. The suits would also have to be lead-loaded for the same reason.

DANGERS EXAGGERATED

The dangers of the cold and vacuum of stratospheric regions has been exaggerated somewhat. A man could probably walk through a damaged compartment in a stratospheric liner in ordinary clothes and suffer little more than a nose-bleed and some frost-bite, instead of instantly turning into a bloated and frozen corpse as fiction writers have often described.

The problem of handling a stratospheric liner damaged by meteorites has been solved by the damage-control systems developed for four-engine bombers and naval men-o'-war damaged in combat or accidental crashes.

Water-tight integrity and elaborate compartmental sub-division as first applied by the German naval design men greatly limits the radius of damage effects. Elaborate communications, repair station and crew battle damage organization has been perfected to a high degree. They depend to a large degree upon efficient PA-type and sound-powered battle-phonie systems. Specially trained hull, machinery, electrical and medical emergency crews are rushed to the scene to stop the spread of damage, rescue the wounded and make swift emergency repairs. Elaborate secondary and emergency circuiting and equipment systems can be rapidly or automatically cut in an emergency to keep the liner's vital equipment functioning.



Frank
BEAVEN,

{ Suggested by: Ralph
B. Lippanen, Winona,
Mich.

"Even with all his money, he couldn't buy a new battery, so he had to get an electric eel."

Thus if a high-velocity meteorite should blast through the hull of a stratospheric ship, through some of the compartment bulkheads and out the other side, instant suffocation and a freezing death would not overtake all the crew members of the giant stratoliner. The gas-tight compartmental sub-division would limit the damage effects to a few compartments actually penetrated by the meteorite. High-speed automatic circuit-breakers would shift the damaged circuits off the main lines and cut in secondary emergency circuits. The crew and passengers within the damaged compartments not struck by the meteorite of flying fragments would quickly don oxygen helmets and electrically heated suits and help rescue the wounded and make emergency repairs. Portable welding outfits, steel patch plates, cable coils, tools and material kits would be taken down from convenient racks and the pierced hull sections and damaged circuits and equipment quickly repaired where possible. Near-normal stratoliner operation would be resumed in short order, providing severe damage had not been suffered. Elaborate P.A. systems would aid in the damage-control, rescue and repair work by setting up greater co-ordination of available manpower and equipment.

The astral navigation and ship stability problem would be simplified by the same type computers and range-keepers developed for gunnery fire-control and the gyroscope and thyatron-tube follow-up systems developed for gyro-compass systems in ocean liners and naval men-o'-war.

Radio communications and recognition equipment and new directional antenna type radio receivers recently developed during this war would also aid in the navigation

problem. Radio beam guide systems as now used by airliners could be employed in conjunction with captive stratospheric balloon-type mid-way stations or rocket-jet-anchored interstellar relay stations to help guide the high-speed rocket-driven ships to their destinations.

At one time the protection of stratospheric or interstellar liners from meteor damage seemed an unsolvable problem. Now not only avoidance protection but positive elimination protection methods could be made possible with such equipment as is available today.

Radio and magnetically guided and rocket driven projectiles could be directed at the onrushing meteors to blast them with super-explosives and consume them with combustion gases. High-speed computers would plot the meteorites' path and the projectile's necessary astral trajectory in order to achieve a direct hit.

Furthermore, ship convoy systems and other protective systems devised during this war could also be applied to further protect interstellar and stratospheric ships against meteors and meteorites. A miniature radio remote-controlled convoy system of midjet stratospheric "satellite" ships could be released from the liner in stratospheric and interstellar regions to surround it in a triple concentric protective shell fashion. They could mount radio and magnetic control devices and be filled with explosive combustion gases. If any high-velocity meteors should get by the ship's navigators and ordnance crews, they could be automatically detected and destroyed by them.

Thus the prediction is made that radio-controlled, rocket-driven projectiles will be launched out of the Earth's stratosphere

and out into space towards the satellite Moon within the ten-year period following the end of World War II, which may not begin till the year 1948.

The End.

Note: Incidentally, why are not rockets lifted by balloons to 15 or 20 mile heights and then triggered off by aneroid type detonators to send them up another ten or twenty miles?

OPPORTUNITY AD-LETS

Advertisements in this section cost 20 cents a word for each insertion. Name, address and initials must be included at the above rate. Cash should accompany all classified advertisements unless placed by an accredited advertising agency. No advertisement for less than ten words accepted. Ten Percent discount six issues, twenty percent for twelve issues. Objectionable or misleading advertisements not accepted. Advertisements for December, 1944, issue must reach us not later than October 28, 1944.

Radio-Craft • 25 W. B'way • New York 7, N. Y.

FOR SALE—3-2½ METER ABBOTT TRANSMITTER, Receiver, TR4's, including Mallory vibrapacks 552's, with auxiliary high voltage filters, and Mallory battery chargers. Microphones and cables included, condition like new. J. S. Holden, R.E., 405 Tarkilla Hill Rd., New Bedford, Mass.

PREPARE NOW FOR TREMENDOUS OPPORTUNITIES in new fields of radio after the war. Training for Federal licenses. Write for Particulars, American Radio Institute, 44 East 23rd Street, New York 10, N. Y.

USED CORRESPONDENCE COURSES AND TECHNICAL Books Bought, Sold, Rented, Catalog Free. Educational Exchange, Menager, Alabama.

TEST INSTRUMENTS, METERS, OSCILLOGRAPH and radio parts wanted for cash. Send list to John Hart, 44 East 23 St., New York City.

SAL-AMMONIAC TINNING BLOCKS 50 AND 75 cents. Dealers wanted. Opportune Products, Box 8, Normandy 21, Mo.

WE PAY HIGHEST PRICES FOR USED RADIOS, playing or not. Corney's Radio Shop, Buxton, Ga.

PRACTICAL HOME-STUDY

RADIO COURSE

These men used this course to get into good radio jobs



FINEST TRAINING COURSE USED IN MANY SCHOOLS

"The radio training course is the finest up to date easy to understand course. . . . This course outlines practical work. We are using this course in our Topeka High School. It is wonderful."
Henry Ward, Jr., 622 Filmore St., Topeka, Kansas.



WORTH MUCH MORE

"You should get more money for your Course. The first week I studied it, I made \$10.00 repairing sets. I built my own test outfit from details given in this course. I have repaired 100 radios to date."
Robert C. Hammel, 709 E. 10th St., Davenport, Iowa.



COMPLETED IN 8 WEEKS

"I am very satisfied with the course. When I was at the twelfth lesson I started repairing radios. It took me two months, to master your course."
Roger Lanzlois, 1720 Poupard, Montreal, Canada.



MODERN, UP-TO-DATE

"I have found since taking your course how modern and up to date it really is. There is not one page in the whole course which anyone interested in radio can afford to miss. Your course started me on the road to a well paid job and has REPAID me many times."
Charles Alspach, 433 Elm St., Reading, Pa.

AMAZING BARGAIN OFFER

In this large course-manual of 22 practical lessons, you have the material covered by the best \$100.00 radio correspondence course. Learn important fundamentals. Speed-up radio servicing. Includes all modern topics, hundreds of circuits, thousands of repair hints, many servicing short-cuts.

RADIO TRAINING FOR HOME-STUDY

This practical home-study course will show you how to repair all types of sets faster and better, tell you how to open your own shop and run the business. The lessons are well illustrated, interesting to read, easy to understand and apply. No special previous knowledge is needed. The early lessons explain to you important principles. Other lessons cover test equipment, trouble-shooting, circuit tracing, television, and every other important radio topic.

SERVICING METHODS SIMPLIFIED

Learn new speed-tricks for radio fault-finding, case histories, servicing short-cuts, extra profit ideas. Included are many large lessons on the use of regular test equipment, explanation of signal tracing, oscilloscope, transmitters, television, recorders. Let this information save for you enough time on a single job to pay the full price of \$2.50 for the complete course of 22 money-making lessons.

Money-Back Guarantee

You must be entirely satisfied or your money will be immediately refunded. You are permitted to make full use of the course for 10 days, on a trial basis.
Supreme Publications

IN MANUAL FORM

\$2.50 COMPLETE

SPECIAL OFFER
READ THE DETAILS

EASY TO UNDERSTAND AND APPLY

The practical lessons making up this course-book are easy to follow and apply to actual radio jobs. Hundreds of radio facts that puzzled you will be quickly cleared up. You will find yourself doing radio repairs in minutes instead of hours—quickly finding the faults or making needed adjustments. Every new radio development of importance and thousands of time-saving radio facts are packed into this complete course-manual available now for only \$2.50, postpaid, on "no risk" trial.

SATISFACTION GUARANTEED

Use coupon to order the Course for 10-day examination in your own home. Look over the material, read a few lessons, apply some of the ideas. Then decide to keep the lessons at the bargain price of \$2.50 (full price), or return the material and get a cash refund.

TRIAL ORDER COUPON

SUPREME PUBLICATIONS, 9 S. Kedzie Ave., Chicago 12, Ill.
Ship the complete Radio Course for 10 days use. I must be satisfied or you will refund my money.

- I am enclosing \$2.50, full price. Send postfree.
 Send C.O.D. I am enclosing \$..... deposit.

Name: RCN

Address:

(Use Coupon or Send Order in a Separate Letter)

AMPLIFIER MANUAL

By **A. C. SHANEY**

Chief Engineer, Amplifier Co. of America

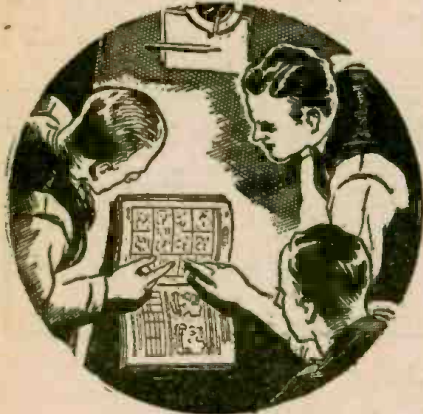

**For the Layman, Serviceman
Recordist and Engineer**

Regardless of whether you are interested in the finest type of phonograph reproduction, high fidelity recordings, sound-on-film applications, FM or AM programs, you will find invaluable information in this practical handbook. Written by the leading exponent of direct-coupled amplifiers who has spent more than 10 years improving and perfecting the famous Loftin-White circuit.

Explains the theory and practical application of:

- Variable Speed Non-Overloading Push-Pull Expansion
- Non-Frequency Discriminating Scratch Suppression
- Push-Pull Balanced Direct-Coupled Amplification
- Push-Pull High-Frequency Equalization
- Push-Pull Low-Frequency Equalization
- Push-Pull Volume Compression
- Automatic Volume Limitation
- Automatic Volume Control
- Calibrated V. U. Indicator
- Audio Spectrum Control
- Remote Control

If you are interested in the latest audio developments, you can't afford to be without this complete compilation of authentic articles on Direct-Coupled Amplifiers. 33 pages 8 1/2" x 11". Over 100 diagrams and illustrations.

Priced to Cover Cost of
Printing and Mailing **25c**

Send U. S. Stamps or Coin

AMPLIFIER CO. of AMERICA

396 BROADWAY

NEW YORK, N. Y.

ELECTRICITY



**Prepare for a Peace
Time Future**

Electricity offers you opportunities for the best jobs today—with a real peace time future. Learn by "Doing" on real machinery. Earn while learning. Right now I'm offering extra training in Industrial Electronics at no extra cost. Lifetime employment service after graduation. Get all-around practical training at Coyne in 12 weeks. If you are short of money, I'll finance your training. Mail coupon now for Free Book and all details. No obligation and no salesman will call. I want to send you the facts and you decide.

H. C. LEWIS, President, COYNE ELECTRICAL SCHOOL
500 S. Paulina St., Dept. 84-78, Chicago 12, Ill.
Send free book and all details.

NAME _____
ADDRESS _____
CITY _____ ZONE _____ STATE _____

**Radio
AND
ELECTRONIC
DEVICES**

BURSTEIN-APPLEBEE CO.
1012-1014 McGee St. • Kansas City 6, Missouri

ECONOMY 20-WATTER (Continued from page 92)

feedback gain reduction) drives the second section, thereby increasing its output.

Between the phono pick-up input and the grid of the first 6SC7 is a resistance capacity network giving a bass boost of approximately 8db at 100 cycles per second and 13db at 50 c/s to compensate for the attenuation of bass in the ordinary lateral recording. The network has an impedance of approximately 30,000 ohms at mid-frequencies, that being the load required for the pick-up employed. Should an ordinary crystal pick-up be employed, then the large condenser in the network must be shorted and each resistance increased in value 20 times. For an ordinary magnetic pick-up, the network can be left as it is for a pronounced bass, or the large condenser can be bridged by a 3000 ohm resistor for a more normal bass reproduction.

PARALLEL MIXING

It may be wondered why electronic mixing is not used as there is a triode section for each input. This would mean, however, the placing of each volume control right at the input—a quite sound arrangement only if each control is quite free from noise and can be completely shielded. The writer has found in practice that the conventional parallel mixer circuit shown is much better. Theoretically the movement of the microphone volume control should slightly change the volume from the pick-up and vice versa, but in practice the change is negligible, and is reduced still further in this amplifier by the tone-compensation resistors connected between the moving contact and grounded end of each volume control. These resistors reduce the bass response at full output to make up for the ear being relatively more sensitive to the lower frequencies at high volume levels and to prevent overload of the speaker. It is not com-

monly realized that the power handling capacity of a speaker is restricted in the low frequency region. A speaker capable of handling 30 watts at 400 cycles may be able to handle only 5 watts at 30 cycles, providing it has the same efficiency at the lower frequency. Nothing is more distasteful than the banging of a speaker diaphragm on the low-frequency peaks—generally the freer the suspension and the lower the resonant frequency, the more liable is the diaphragm excursion to be excessive.

THE TONE CONTROL

In order that worn records may not sound too bad and to eliminate some of the harshness from overpowering vocalists who hug the microphone, a simple high-cut filter is connected across the output, a variation in capacity is used in place of a fixed capacity and variable resistance as the lack of a resistance gives a sharper cut-off. The filter is placed at the output for the same reason, the rise in impedance of the speaker at the higher frequencies producing a sharper cut-off. It should be noted that this tone control is not so much to control tonal balance as to permit more pleasant reproduction. If a wider range of control is required, more points could be fitted and larger condensers used on the switch. As the voltage between each output anode and the chassis consists of the high voltage (400 volts) together with the peak value of the output signal (about 320 volts), any condenser connected between the output anode and chassis is liable to breakdown. Greater reliability is obtained by connecting 600-volt condensers in series as shown so that there are always at least two condensers in circuit, giving a minimum working voltage of 1200.

To handle the 20 watts output without excessive weight a model TX Amplion

A unique radio tower is this Harco Bantam King. Made up in sections 4 feet square and 6 feet in height, it is the same size from bottom to top. All sections are interchangeable, and the complete tower may be either 30, 50, 100 or 150 feet high, or intermediate submultiples of six feet.

Photo Courtesy Harco Steel Construction Co., Elizabeth, N. J.

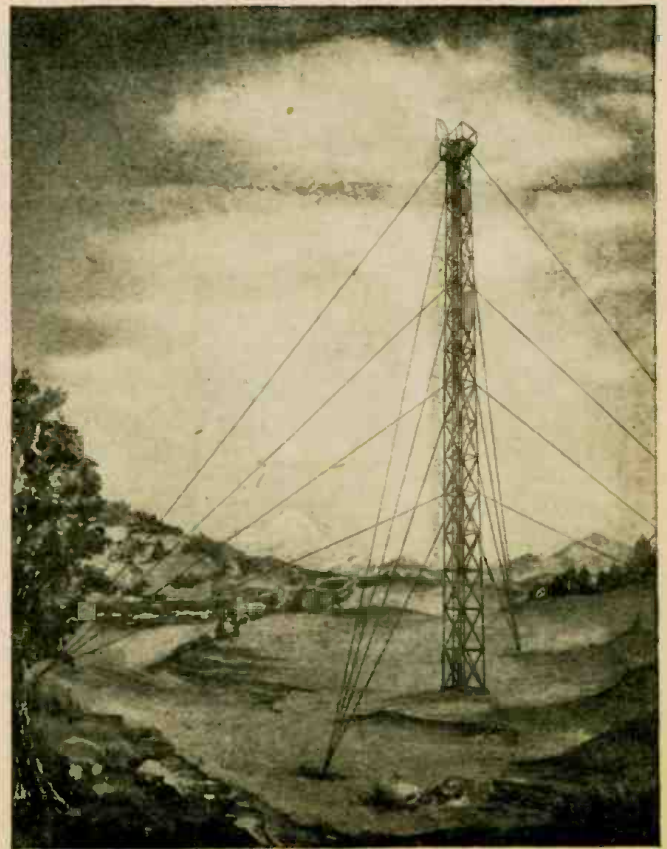

speaker transformer is used. Alternative types are available in the Rola range and no doubt American enthusiasts can find dozens of suitable brands. The transformer is mounted on the chassis so that there is no high voltage between the speaker leads, which are run at voice-coil impedance (12.5 ohms in this case). There are two 12.5 ohm outlets (connection is made by UX sockets at the back of the chassis) so the output transformer is wound with a 6.25 ohm secondary. A pair of terminals on the front of the chassis go to this 6.25 ohms winding so that leads can be run to a booster amplifier or to a pair of public address horns.

The speakers normally used are a couple of 12P64 Amplions, each being capable of handling the 20 watts output by itself. Alternatively a single Rola G12 permag. can be connected to the terminals on the front, the very slight mismatch being of no importance and not detectable by ear. If a dynamic type of speaker must be used, a 750 ohm field can be substituted for the filter choke with a reduction in power output to about 15 watts. At full volume, the field energization is about 8 watts so the magnetic circuit must be of high efficiency. Suitable Australian speakers are the Amplion TO75, a 10-inch heavy duty dynamic with a 1½-inch voice coil, or a Magnavox 182. Suggested American speakers are the Jensen A15PM, the Lafayette P12G or the Utah G12P.

HUM REDUCTION

A very low hum level is obtained for several reasons. All earth returns are made to a busbar consisting of a strip of copper ¼-inch wide, this being connected to the metal chassis at one point only—just near the No. 1 terminal of the first 6SC7. Small shields of tin-plate are soldered to the chassis in appropriate places to electrostatically screen the .5 megohm mixing resistors, the anode resistors of the first tube and the pick-up bass-boost network. The input connections are made by means of UX and UZ tube sockets and these, too, are shielded.

The filament wiring is connected to a simple voltage divider, thereby being about 35 volts positive with respect to the chassis, and therefore making the grids about 35 volts negative with respect to the filaments, thus preventing filament emission.

A final reduction in hum is, of course, obtained from the negative feedback.

ACCESSORIES USED

The *phono pick-up* is a four-pole needle-armature type with an output of about .4 volt. It has negligible bass boost owing to the mass of the head being large, hence the boosting network. Although the pick-up head is heavy, a counter-balance reduces the thrust on the record to about 1 ounce, only a small thrust being needed on account of low needle point impedance.

The *microphone* generally employed is either an Australian version of the D104 or a Shure model 9822A. Sometimes a semi-directional floating-cone dynamic microphone is used when wide-range music is to be amplified. The amplifier is not suited for use with sound-cell mikes or low-level dynamics.

The tone and volume of this amplifier are surprisingly good, the freedom from unpleasant distortion enabling the speakers to be placed close to the audience without exciting rude remarks.

TWO CORRECTIONS

In the "Electronic Multi-Checker" printed on page 481 of the May issue, the plate of the 6E5 electron-ray tube is shown connected to ground. This would of course make the apparatus inoperative. The 16 and .001 mfd. condensers are grounded, but the connection between them and the 6E5 plate should not be there.

The control and screen-grids of the "3-Tube Phono Amplifier," on page 744 of the September issue were transposed. They should be hooked up in ordinary pentode fashion. Also, the dash between the figures denoting the cathode resistor value (125-200 ohms) was changed to a comma. (If a 6F6 is used, this value can be increased to 400 ohms.)

"Longest direct radio circuit in the world" was announced by RCA Communications, Inc., with the opening of their radio-telegraph service between New York and Bombay, which started operation August 15.

ELECTRICITY

for Radio and Electronic Applications

ONAN ELECTRIC GENERATING PLANTS supply reliable, economical electric service for electronics applications as well as for scores of general uses.

Driven by Onan-built, 4-cycle gasoline engines, these power units are of single-unit, compact design and sturdy construction. Suitable for mobile, stationary or emergency service.

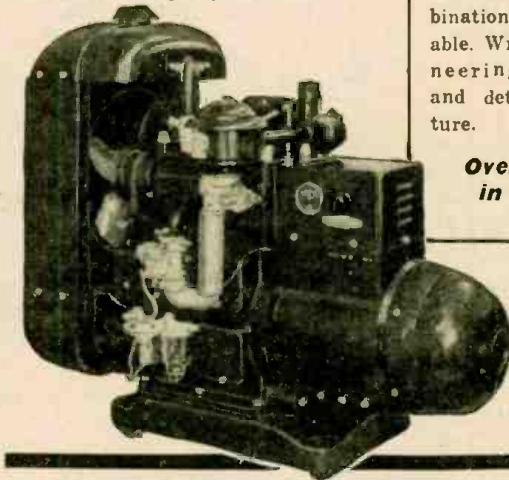

Over 65 models available ranging in sizes from 350 to 35,000 watts. A.C. types are 50 to 800 cycles, 115 to 660 volts, single or three - phase. D.C. types from 6 to 4000 volts. A.C.-D.C. combination types available. Write for engineering assistance and detailed literature.

Over 200,000 in service

Model Shown is from W2C series. 2 and 3-KW, 60-cycle, 115 volt; powered by water-cooled, 2-cylinder engine.

D. W. ONAN & SONS 739 Royalston Ave., Minneapolis 5, Minn.

Announcing a change of name!
Henceforth, the Lafayette
Radio Corporation (Chicago and Atlanta)

CONCORD RADIO CORPORATION



The Lafayette Radio Corporation has, for 22 years, been one of the well-known names in radio and electronics. Our policies and our personnel, our reputation for integrity and outstanding service to our customers have enabled us to become one of the nation's great arsenals of radio and electronic equipment. In announcing the change of name to the Concord Radio Corporation, we emphasize that the name only is affected. To our thousands of customers, we promise a continuance and broadening of our organization and our policies. With the advent of new and greater horizons in electronics, the Concord Radio Corporation, will blaze new trails in engineering achievement and customer services. Watch for our future advertisements, and be sure that your name is on our list to receive postwar literature and catalogs.



CONCORD RADIO CORPORATION
901 W. Jackson Blvd. Dept. RC-11
Chicago 7, Ill.

Please rush me the new 16-page "Special Flyer" just published by the Concord Radio Corporation.

NAME
ADDRESS
CITY STATE

Just off the Press!

NEW, 16-PAGE "SPECIAL FLYER"
... a last-minute compilation, by
the CONCORD RADIO CORPORATION,
of hard-to-find components and
equipment for industry, service
men, training schools, etc. MAIL
COUPON TODAY.

CONCORD RADIO CORPORATION
Lafayette Radio Corporation

901 W. Jackson Blvd., CHICAGO 7, ILLINOIS ★ 265 Peachtree St., ATLANTA 3, GEORGIA



IS *Your* OPPORTUNITY HERE?

Think this over carefully. Where do you go from the spot you're in now? Are your surroundings friendly and full of promise for the future? Consider now the place you might fill in the electronic industry leadership assured to the fine staff of engineers, scientists, technicians at NATIONAL UNION RADIO CORPORATION. We're all young in years and ideas though most of us are old in electronic experience. We enjoy working together. We know we're going places! We're inviting you to join us if you have the qualifications. If you're looking for a success pattern for your future, it may be here with us at National Union. Find out! Come in and talk it over or write us!

NATIONAL UNION WANTS:

- * **QUALITY CONTROL ENGINEER AND SENIOR TUBE ENGINEERS**—These men **MUST** have executive ability and extensive experience with radio tube manufacture. The pay and opportunities are commensurate with your ability.
- * **COMMERCIAL ENGINEERS**—Men with pleasing personalities, initiative and a knowledge of vacuum tube applications.
- * **QUALITY CONTROL MEN**—Statistical Training is chief requirement though a knowledge of vacuum tubes will help.
- * **JUNIOR ENGINEERS—MEN or WOMEN**—If you have a college degree in Physics, Electrical Engineering, Mathematics or Chemistry and are the type of young person who is able to 'go places,' you'll be starting with your best foot forward if you are accepted at National Union Radio Corporation.
- * **FOREMEN and ASSISTANT FOREMEN**—Men with foremanship experience in exhaust, stem or grid operations in radio tube manufacture.
- * **TECHNICIANS, CIRCUIT MEN**—Maybe you've been repairing radios, maybe you've gained a knowledge of circuits by working on test equipment. It makes no difference either way if you have the 'know how' of circuits write us about the opportunities we have to offer!

WOMEN!

We have a number of fine young women engineers with us now. We need more. If you have a degree in Electrical Engineering, Physics, Chemistry or Mathematics and are seeking career opportunities, investigate.

Phone or Write

DR. L. GRANT HECTOR

Director of Engineering

NATIONAL UNION RADIO CORPORATION

RESEARCH LABORATORIES

Plane St. at Raymond Blvd.

Newark 2, New Jersey

WMC RULES OBSERVED

ELECTRICAL and RADIO ENGINEERS RADIO TECHNICIANS

FOR DESIGN, DEVELOPMENT
AND PRODUCTION WORK
POST WAR OPPORTUNITY

ALLEN D. CARDWELL MFG. CORP.

81 Prospect St.

Brooklyn

Radio-Craft regrets that due to lack of space, it has been necessary to omit slightly more than eleven columns of advertising matter.

Wanted ENGINEERS

- Radio
- Chemical
- Electrical
- Electronic
- Mechanical
- Metallurgical
- Factory Planning
- Materials Handling
- Manufacturing Planning

Work in connection with the manufacture of a wide variety of new and advanced types of communications equipment and special electronic products.

Apply (or write), giving full qualifications, to:

R. L. D.

EMPLOYMENT DEPARTMENT

Western Electric Co.

100 CENTRAL AV., KEARNY, N. J.

Applicants must comply with WMC regulations

ELECTRONIC

ENGINEERS
TECHNICIANS
DESIGNERS
DRAFTSMEN
TUBE TECHNICIANS

EXCELLENT OPPORTUNITIES
IN A MAJOR POST-WAR FIELD!

Openings available at our Research Laboratories and Electronics Manufacturing Unit. Leaders in the design and development of vital electronic equipment for the Armed Forces.

Essential workers need release.

Write, stating Experience, Education, Draft Status, Salary. Include snapshot if available. Or apply to

SPERRY

GYROSCOPE COMPANY, INC.
RESEARCH LABORATORIES
STEWART AVE. & CLINTON RD.
GARDEN CITY, NEW YORK

RADIO and P. A. TECHNICAL and SALES CORRESPONDENT

Assistant to department head. Permanent position now and postwar with large Chicago distributing organization doing nation-wide business. Sales ability and good practical technical knowledge essential. Excellent opportunity for right man in a long-established concern that is still growing. Give experience, education, age, salary. Address BOX NO. 1101, c/o RADIO-CRAFT, 25 West Broadway, New York 7, N. Y.

SILENT RECORDING METHODS

(Continued from page 90)

ness, convenience and low cost, this type of photography was most popular.

A method of sound recording which would automatically accompany slide-film strips, such as an explanation of the scene, pointing out certain persons involved or date and time of exposure would naturally be of great interest and add to its usefulness. This method also would have great advertising and commercial possibilities, besides home use.

Such a recording method has been recently patented by Conkling Chedister of Livingston, N. J. Since the speed of the phonograph is uniform, the strip of film must be advanced one frame at a time automatically in step with the talk. Use is made of a super-audible frequency as the control, (above 10 Kc.).

The sound sequence is recorded through the microphone and amplifier on the disc (Fig. 4). While the microphone is energized, power will be supplied through a second amplifier to actuate the relay which closes and cuts off the source of super-audible oscillations. During periods of silence, however, the relay opens as shown and these oscillations are recorded instead. Normally then, either audible or inaudible frequencies are recorded. Now, when it is desired that the next frame be moved into place, the double-pole switch is thrown so that a completely silent portion exists on the disc. A pilot light acts as monitor.

In playing back use is made of a motor which will move the film strip one frame every time a silent piece is encountered. If either audible or inaudible recording is on the disc, the motor remains stationary. A relay in series with the motor opens while any frequency is recorded. The picture will then be synchronized with comment.

PHASE MODULATED RECORDING

The great advantages of phase modulation are now available for sound recording. An invention by Walter van B. Roberts of Princeton, N. J., makes possible noise elimination and a high fidelity system. Referring to Fig. 5, incoming sounds at the microphone phase modulate a carrier of 21 Kc. The latter frequency is first generated by a master oscillator at 7 Kc., which passes through a tripler. Both the original 7 Kc. and the phase modulated 21 Kc. actuate the cutter as shown.

Fig. 6 shows the set-up for playback. The reproduced frequencies are amplified. They are separated, each passing through its own limiter which slices off any irregularities which in other systems cause noise. The two channels (both now 21 Kc. one modulated) are combined in the phase modulation detector, which converts changes of phase to changes of amplitude. A conventional A.F. amplifier follows. Even though the cutter may discriminate between frequencies, the action of the limiter will eliminate this amplitude modulation and result in high fidelity and wide range without distortion.

COMPRESSION-EXPANSION

It is well known that in all types of recording and even in broadcasting, it is necessary that the dynamic range be compressed at the source. In other words, the softer passages must be brought up so that they will not be lost in the noise level while the louder passages must be toned down so that they will not overload the system. This is a necessary procedure due to the limitations of all recorders and, of course, results in destroying to some extent the wide range of the original.

(Continued on following page)

RADIO-CRAFT (or NOVEMBER, 1944

ENGINEERS

Are You Concerned With ? YOUR POST WAR FUTURE ?

The Federal Telephone & Radio Corporation, the manufacturing unit of the International Telephone & Telegraph Corporation with its multiple business activities extending to all parts of the civilized world, will accept applications from experienced men for immediate employment with almost limitless post war possibilities. These positions should interest those with an eye to the future and whose interest lies in forging ahead with this internationally known organization whose expansion plans for post war are of great magnitude covering all types of radio & telephone communications. Advancement as rapid as ability warrants. Majority of positions are located in the New York area!

We need the following personnel! Men with long experience or recent graduates considered.

- ENGINEERS
- ELECTRONICS
- ELECTRICAL
- RADIO
- MECHANICAL
- CHEMICAL
- TRANSFORMER DESIGN
- SALES AND APPLICATION ENGINEERS
- PHYSICISTS
- DESIGNERS
- DRAFTSMEN
- TOOL DESIGNERS
- TECHNICAL WRITERS

Look Ahead With Federal!

If inconvenient to apply in person, write letter in full, detailing about yourself, education, experience, age, etc., to Personnel Manager.

FEDERAL TELEPHONE & RADIO CORP.

39 Central Avenue

EAST NEWARK

NEW JERSEY

WANTED

Electrical Engineers Mechanical Engineers & Draftsmen

Experienced in design of
AC/DC electrical indicating instruments
New Modern Plant

Excellent post-war future assured

Apply in person.

Write or phone for appointment.

DeJur Amsco Corporation

45-01 NORTHERN BLVD.
LONG ISLAND CITY, L. I.

IND Sub. 46 St. **WMC Rules Observed** Astoria 8-1040

Broadcasting, according to FCC chairman James Lawrence Fly, can contribute materially to full post-war production and employment.

"At the very moment when returning soldiers are coming back for jobs and manufacturers are turning from war to peace production, broadcasting will be launching vast new projects for public service," Mr. Fly said.

"Frequency modulation and television, the two great ventures which lie ahead, insure that broadcasting will do its share to see that the post-war era is one of expansion and prosperity, rather than contraction and depression."

ENGINEERS DESIGNERS

ELECTRICAL, MECHANICAL,
RADIO, ACOUSTICAL

For Research and Development Laboratory of large company fully engaged in war work manufacturing aircraft accessories. Activity includes electronic control equipment, continuous recorders, special radio devices, etc.

Excellent post-war opportunities. Laboratory located in central Manhattan. All replies strictly confidential. Write full details. Box 550 Equity, 113 W. 42nd St., N. Y. C.

FOR SALE HARD-TO-GET ITEMS

All items are brand new, except where indicated. ALL are in PERFECT WORKING ORDER. In many cases, the parts alone total more than the price we are asking. Satisfaction guaranteed or your money back. ORDER FROM THIS PAGE. Use our convenient coupon. Include sufficient extra remittance for parcel post charges, otherwise order is sent express collect. Any excess will be refunded. All C.O.D. shipments require 20% deposit. No C.O.D. shipments on orders for less than \$5.00. If full remittance accompanies order, deduct 2% discount. Send money order, certified check, or new U. S. stamps. No C. O. D.'s to foreign countries.

THE MAGIC ELECTRIC WELDER



Here is one of the most compact. Practical welders we have ever seen. Anyone can use it for shop, farm and home repairs. WELDS, BRAZES, SOLDERS. CUTS ALL METALS. ANYONE CAN OPERATE IT. Repairs steel, cast iron, aluminum, brass, copper, bronze, etc. Complete with power unit, flame and metallic arc attachment.

ments. (Really two welders in one). Carbons, fluxes, rods, mask included. Just plug it in any electric outlet. 110 volts AC or DC. For hobbyist or professional. GET IN ON THE GREAT WELDING BOOM. This one set quickly teaches you welding. Low cost to operate—about 5¢ an hour. COMPLETE SAFETY is assured. No fumes with this outfit. SET COMES COMPLETE—nothing else to buy. Used by the U. S. Navy, American Tel. & Tel. Co.; Eastman Kodak Co., Bell Laboratories, etc. BRAND NEW OUTFIT. Guaranteed for one year. SIMPLE INSTRUCTIONS with each set. ITEM NO. 158 YOUR PRICE \$19.95

WESTERN ELECTRIC BREAST MIKE

This is a fine light-weight aircraft carbon microphone. It weighs only 1 lb.

Mike comes with breastplate mounting and has 2-way swivel adjustment so that it can be adjusted to any desired position. There are 2 woven straps; one goes around neck, the other around chest. Straps can be snapped on and off quickly by an ingenious arrangement.

This excellent mike can be adapted for home broadcast, or private communication systems. By dismantling breastplate, it can be used as desk mike.

Comes complete with 6-foot cord and hard rubber plug. Finished in shatterized plate, non-rustable.

THIS IS A BRAND NEW MIKE. IT HAS NEVER BEEN SOLD AT SUCH A LOW PRICE BEFORE. ORIGINAL LIST PRICE \$15.00. Shipping weight, 2 lbs. ITEM NO. 152 YOUR PRICE \$2.55

POWERFUL ALL-PURPOSE INDUCTION MOTOR

IDEAL FOR EXPERIMENTERS—101 USES



Sturdily constructed to precision standards, this self-starting shaded pole A.C. induction motor is powerful enough for a number of uses. Some of these are: Automatic Timing Devices, Current Interrupters, Electric Fans, Electric Chimes, Window Displays, Photocell Control Devices, Electric Vibrators, Small Grinders, Buffers and Polishers, Miniature Pumps, Mechanical Models, Sirens, and other applications.

Consumes about 15 watts of power and has a speed of 3,000 R.P.M. When geared down, this sturdy unit will constantly operate an 18-inch turntable loaded with 200 lbs. dead weight—THAT'S POWER!

Dimensions 3" high by 2" wide by 1 1/2" deep; has 4 convenient mounting studs; shaft is 1/8" long by 3/16" diameter, and runs in self-aligning oil-retaining bearings. Designed for 110-20 volts, 50-60 cycles, A.C. only. Shp. Wt. 1 lb. ITEM NO. 147 YOUR PRICE \$2.25

LIMITED QUANTITIES! PROMPT SHIPMENTS!

It's Easy to Order—Clip Coupon—Order from This Page—No Catalog Sent.

MAIL TODAY—NOW!

HUDSON SPECIALTIES CO.

40 West Broadway, Dept. RC-11-44, New York, 7, N.Y.

I have circled below the number of the items I'm ordering. My full remittance of \$_____ (include shipping charges) is enclosed (NO C.O.D. ORDERS UNLESS ACCOMPANIED WITH A DEPOSIT.)

OR my deposit of \$_____ is enclosed (20% required), ship order C.O.D. for balance. (NO C.O.D. ORDER FOR LESS THAN \$5.00. (Now U. S. stamps, check or money order accepted.)

Circle Item No. wanted: 147 152 156

Name _____

Address _____

Please Print Clearly

City _____ State _____

Send remittance by check, stamps or money order; register letter if you send cash or stamps.

(Continued from previous page)

In order to restore the reproduction range, an automatic system has been invented by Chester M. Sinnott, Westmont, N. J. In Fig. 7 we show that the A.F. source connects to a controlled amplifier whose gain

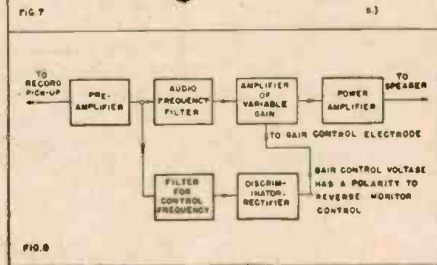
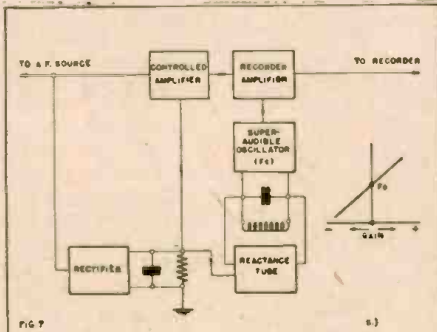

depends upon the bias across the rectifier output. This bias in turn depends upon the strength of sounds to be recorded. Therefore, the louder the sound the less the gain.

This bias simultaneously acts upon a reactance tube to vary the frequency of a super-audible oscillator. As the incoming sound becomes louder it raises the oscillator frequency and vice versa (Fig. 7a). Two frequencies are thus recorded on the disc, the actual sound and a super-audible modulated frequency.

When being played back the recorded frequencies are passed through an amplifier (Fig. 8) and separated. The super-audible control frequency goes to a discriminator-rectifier which serves to vary the amplifier gain in a reverse sense (to expand the range). Therefore, the range which has been automatically compressed in recording is now automatically expanded so that the original dynamic range is available at the speaker.

The above-described developments are all very recent and it should be kept in mind that the basic ideas involved are protected by patents.

TWO NEW PREDICTIONS

POST-WAR predictions are entering the quantitative stage, to judge by two recent reports. In Chicago H. A. Crossland, General Electric sales manager, assured the National Association of Music Merchants that within 18 months after the war no less than five million FM receivers will be on the market. Prices, he said, would average about \$60.00, and receivers would be capable of receiving AM as well as FM programs.

This prediction follows that made by T. F. Joyce, manager of RCA's radio, phonograph and television department, who stated that within 18 months after television receivers become available, 741,000 homes will be equipped. He believes that this would mean more than four million spectators, as an average of nearly six persons per machine may reasonably be expected. Television receiver prices would be about \$200.

FOR SALE HARD-TO-GET ITEMS

All items are brand new, except where indicated. ALL are in PERFECT WORKING ORDER. In many cases, the parts alone total more than the price we are asking. Satisfaction guaranteed or your money back. ORDER FROM THIS PAGE. Use our convenient coupon. Include sufficient extra remittance for parcel post charges, otherwise order is sent express collect. Any excess will be refunded. All C.O.D. shipments require 20% deposit. No C.O.D. shipments on orders for less than \$5.00. If full remittance accompanies order, deduct 2% discount. Send money order, certified check, or new U. S. stamps. No C. O. D.'s to foreign countries.

ULTRA MAGNET

LIFTS MORE THAN 20 TIMES ITS OWN WEIGHT

LITTLE GIANT MAGNET

Lifts 5 lbs. easily. Weighs 4 oz. Made of ALNICO new high-magnetic steel. Complete with keeper. World's most powerful magnet ever made. The experimenter and hobbyist will find hundreds of excellent uses for this high quality permanent magnet. Measures 1 1/4" x 1 1/4" Shp. Wt. 4 1/2 lbs. ITEM NO. 159 YOUR PRICE \$1.50



GENUINE MICROPHONE TRANSMITTERS



These are regular "telephone" transmitters of the type used on wall telephones. Taken from a large telephone supply company's overstock, these fine mikes offer a grand opportunity to obtain a splendid unit for little more than the price usually asked for a simple "microphone button."

The amateur experimenter and telephone mechanic will find a variety of uses for these excellent microphones. They work perfectly on 2 dry cells. Can be used on P.A. systems for voice transmissions, in call systems and intercommunication sets. With telephone receivers (radio headphones will do) they may be made into short-line telephone circuits, such as house-to-house or farm-to-farm "phone" lines. You can use them to talk through your own radio, or as concealed dictaphone pick-up units for listening to phone mechanic will find them useful replacements on battery-operated rural telephone lines. THESE ARE GENUINE TRANSMITTERS, MADE BY KELLOGG, WESTERN ELECTRIC AND STROMBERG-CARLSON, excellent in appearance and operation. A remarkable value, and one seldom offered in these times. Shp. Wt. 1 lb. ITEM NO. 160 YOUR PRICE \$1.50

AMAZING BLACK LIGHT!

Powerful 250-Watt Ultra-Violet Source



The best and most practical source of ultra-violet light for general experimental and entertainment use. Makes all fluorescent substances brilliantly luminous. No transformers of any kind needed. Fits any standard lamp socket. Made with special filter glass permitting only ultra-violet rays to come through. Brings out beautiful opalescent hues in various types of materials. Swell for amateur parties, plays, etc.; to obtain unique lighting effects. Bulb only. Shp. Wt. 1 lb. ITEM NO. 87 YOUR PRICE \$2.45

WATTHOUR METER

Completely overhauled and ready for immediate service. Designed for regular 110-volt, 60 cycle 2-wire A.C. circuit. Servicemen use it in their shops to check current consumption of sets, soldering irons, etc. Keeps costs down. If dismantled, the parts alone would bring the price. The elaborate gear train could be used as a counter on machinery of various kinds. Simple to install: 2 wires from the line and 2 wires to the load. Sturdily constructed in heavy metal case. 8 1/4" high, 6 1/4" wide, 5" deep. Westinghouse, G. E., E. T. Varney, Sangamo or other available make. Shp. Wt. 14 lbs. ITEM NO. 33 YOUR PRICE \$5.95

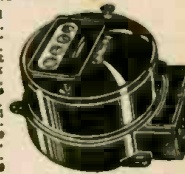

TELEPHONE RECEIVER

This is a standard 75-ohm telephone receiver identical as used by public telephone companies. Slightly used but reconditioned. This telephone receiver has a powerful U-shaped magnet. Genuine hard-rubber casing, two binding posts for connections. No cord is furnished, but receiver will take any standard cord. Receiver is quite sensitive and can be used for a variety of purposes, particularly in connection with our microphone transmitter shown above. Limited quantities. Shp. Wt. 2 lbs. ITEM NO. 162 YOUR PRICE \$1.85

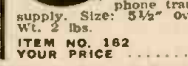

HUDSON SPECIALTIES CO.

40 West Broadway, Dept. RC-11-44, New York, 7, N.Y.

I have circled below the numbers of the items I'm ordering. My full remittance of \$_____ (include shipping charges) is enclosed (NO C.O.D. ORDERS UNLESS ACCOMPANIED WITH A DEPOSIT.)

OR my deposit of \$_____ is enclosed (20% required), ship order C.O.D. for balance. (NO C.O.D. ORDER FOR LESS THAN \$5.00. (Now U. S. stamps, check or money order accepted.)

Circle Item No. wanted: 33 87 159 160 162

Name _____

Address _____

Please Print Clearly

City _____ State _____

Send remittance by check, stamps or money order; register letter if you send cash or stamps.

step more than a few feet without being "reported" as to latitude and longitude.

During the past few years, the manufacture of photoelectric detection has settled down to a fairly standardized form, a typical circuit diagram being given in Fig. 3, where a 25L6 tube has been employed as an amplifier. If a good projection lens is used with a good cell and this particular circuit, excellent results over comparatively great distances may be had. Emphasis however, must be placed on the "good projection lens." This field offers still another reason for the student of electronics to gather more optical information. The future electronic serviceman or engineer will run into optical problems and repairs so frequently he simply cannot avoid contact with the subject. It will be clear that no matter how good the electronic system may be and how sensitive the photoelectric cell, a poor optical system involving a lens which scattered the rays badly would render the whole equipment more or less useless.

Returning for a moment to the diagram, Fig. 3, it will be seen that the capacitor and the potentiometer provide easy sensitivity adjustments and that the system suggested employs self-rectification. A large number of such installations employ D.C. packs.

Fig. 4 shows the response curve or that part of the light spectrum to which the average photocell detector responds. This will perhaps be more intelligible when it is stated that the response of the human eye varies between 400 and 700 millimicrons, in other words between violet and red.

Most amplifiers used for this service in a very large measure are compromises between a certain degree of ruggedness and a certain degree of sensitivity. Excessive amplification is always to be avoided because of the danger of alarm triggering by even the slightest variations in ambient light. Of course, the trouble with ambient light is considerably lessened but not wholly eliminated by the use of suitable hoods over projectors and detector covers or boxes. Such photocells are often masked to a very large degree with black paint, there being left only a small opening large enough to receive the beam.

Careful designing will make these systems fairly foolproof. After all, we cannot assume that professional burglars are going to remain permanently ignorant of ways and means to beat the phototube. What, for instance, might happen to such a system, when one prowler held a flashlight beam on the photocell housing while the second

fellow broke the fence beam and crawled over? He might have been able to do such a thing on the older systems when they first made their appearance but it would be hard to do this today because of sharply focused exciter beams. Light entering such systems from a new angle will invariably trip the relay, so critical is the adjustment.

Light beams used in such systems are also far less visible than they used to be. This is brought about by employing proper filters, which confine the actual emission very largely to the region of the infra-red. Thus the beam of the modern system may pass through even an atmosphere heavily laden with dust and not betray itself.

Most phototube protectors are built on the static principle. That is, the beam is constantly at rest and is in no way interrupted. There is also the modulated beam system where the beam is constantly broken up into small "pieces" by a suitable disc chopper at the transmitter (light) end. This modulated system is illustrated in Fig. 5. The motive power of such systems is supplied with a small synchronous motor which helps to keep the beam tone even and light interruptions may be as numerous as 1500 a second or as low as 500 a second.

Such amplifiers are usually employed with three-stage A.C. amplifiers which are used with an audio bandpass filter, the latter being tuned to the frequency of the beam interrupter. Conversion is made by the use of a diode rectifier which takes the received impulses and converts them into power from which a D.C. relay may be operated.

If such systems receive sufficient light to meet threshold operating conditions, very wide fluctuations in ambient light may be had without in any way paralyzing the equipment or "triggering" it. This is because amplification occurs only at the critical modulation frequency and is pre-set. Current output for the relay is held within operating limits by the use of a form of AVC amplifier circuit. The effect of this is to make the system less sensitive to transient increases or decreases in light intensity. Thus unmodulated light from any source is incapable of operating the relay. This makes for reliable, foolproof operation. This feature is further added to by the employment of modulation frequencies that do not have a harmonic relationship to 60 cycles. Dirty lens or other variables in light systems do not appear to have much effect on the modulated beam system which, more expensive by far than the static systems, are also more reliable.



Suggested by: Parker Radio Service, Pittsburgh, Pa.

"I know, Madame, you have no bedbugs in your house—they're all here in your radio!"

Send Only 10c For This Handy TUBE AND CIRCUIT REFERENCE BOOK



OUR NEWEST GET-ACQUAINTED OFFER!

Here's a handy reference book that meets the demand for simple, easy-to-understand data on substitution of radio tubes. Contains a special section devoted to valuable technical information on tubes and circuits. It's a guide you'll refer to time and again. You can't afford to be without it. Send for your copy today! Only 10c postpaid.

TUBE-BASE CALCULATOR ONLY 25c



Here's just the calculator you've been looking for! Tells you quickly, tube characteristics that enable you to substitute available tubes for those hard to get. Send for one today. Only 25c. We pay the shipping expense.

FREE! Giant Radio Reference Map



Time zones, amateur zones, short wave stations and loads of other valuable information. Printed in colors; size 3 1/2 x 4 1/2 ft. It's yours free! Send 15c to help with packing and mailing.

WE'VE GOT THOSE HARD-TO-GET RADIO PARTS

You'll be surprised at the many hard-to-get parts we've been able to get for you fellows. Mikes, pickups, multi-testers, meters and many other items. They're yours as long as they last. Send today for our latest flyer. It's full of merchandise you've been trying to get! Stocks won't last long, so send today!

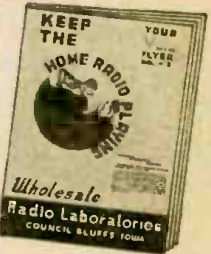

HALLICRAFTERS

For many years we have been one of the country's largest distributors of Hallcrafters equipment. We have Hallcrafters available for immediate delivery on priority. For full particulars, write.

WHOLESALE RADIO LABORATORIES

744 W. BROADWAY COUNCIL BLUFFS, IOWA

—Mail Coupon Today—

Wholesale Radio Laboratories RC-11
744 West Broadway
Council Bluffs, Iowa.

Send your reference book "Tubes and Circuits". Here's my 10c.

You bet I want a Tube-Base Calculator. 25c is enclosed.

Ship me your free radio map. 15c is enclosed for packing and mailing.

Send your free flyer of hard-to-get radio parts.

Name _____

Address _____

Town _____ State _____

I am an amateur; experimenter; service man.

Come to the famous

COYNE TRAINING SHOPS

where you learn by doing



TRAIN FOR RADIO ELECTRONICS IN 12 WEEKS

Prepare For A War Time Job Now With A Peace Time Future!

Trained Radio-Electronics men needed now. They will be needed too when the war is over. Don't be caught napping. Get a Radio training now and be ready when the war is over. Learn by Doing. Free employment service for life after graduation. Many earn while learning. If you are short of money, I'll finance your training. I will include extra training in Industrial Electronics at no extra charge. We also have facilities for men with physical disabilities. Write for details. I'll send you all details of my training and my offers. Fill in and mail coupon.

SEND COUPON FOR FULL DETAILS

H. C. LEWIS, President,
COYNE ELECTRICAL & RADIO SCHOOL,
500 S. Paulina St., Dept. 84-88, Chicago 12, Ill.
Send Big Free Book about Coyne Spare Time Employment, "Pay After Graduation" Plan, and Extra Industrial Electronics training.

NAME.....AGE.....

ADDRESS.....

CITY.....ZONE.....STATE.....

Send for ---

McGee's Fall RADIO FLYER

Sensational Vibrator Supply—
replaces batteries on Farm Radios.

SPECIAL—Substitute Adapters and Tubes

Latest Radio Supply Merchandise.
Write for your copy—TODAY.

McGee Radio & Electric Co.
R-1044, 1225 McGee St. Kansas City, Missouri



CANNON BALL

is a good Headset guaranteed to satisfy you. For sensitivity, clarity of tone, dependable performance, use a Cannon-Ball headset. Folder R-11 illustrates complete line. Write

Scientifically Built
Heavy bar magnets greatly increase their efficiency.

C. F. CANNON COMPANY
SPRINGWATER, N. Y.

Headset Headquarters

Guaranteed Rebuilt Radio VIBRATORS—\$1.00 ea.

Send old vibrator. For very prompt delivery, enclose remittance and return postage. We rebuild any make or kind of vibrator or relay. Vibrator packs rebuilt also. Send your old vibrator to
BEST VIBRATOR CO., Box 5802-Z, Cleveland 1, O.

PATENTS—TRADE MARKS

Booklet concerning Inventions & Patents Form "Evidence of Conception" with instructions for use and "Schedule of Government and Attorneys Fees"—Free
LANCASTER, ALLWINE & ROMMEL
Registered Patent Attorneys

436 Bowen Bldg. Washington 5, D. C.

The Mail Bag

A STURDY DEFENDER OF THE ELECTRON

Dear Editor:

Your letter by Mr. Skelton published in the MAIL BAG for July has simply forced me to write, along with my renewal of *Radio-Craft*.

The magazine is really tops, although according to my needs at present it should have more meat on utilizing old sets and equipment. I know you cannot please everyone or cram in one publication everything electrical that will please everyone, so let's leave well enough alone. It's tops! Unless you want to double the "meat" and double the price.

And now, coming to Mr. Skelton, I would like to know how he came to hatch such an idea on electric current, especially when he says there is no such thing. I believe that Mr. Skelton cannot be anything but all muddled up, as he contradicts himself. He says there could be no such thing as an electron or proton. Then he tells us to "think" of the electron as if it had a north

and south pole.

Kind of a bun steer, isn't it? Then he tells us that when the electron theory was first advanced it seemed to fill most of the requirements. Will he please cite the instances where it does not? Why not give the readers a helping hand instead of steering them on to another entirely different track.

Sure, Dr. Ehrenhaft has discovered the "magnetic current," as he chooses to call it, and at first glance it might lead us to forget or discard the electron theory. But to me it substantiates the electron theory all the more, being the connecting link between magnetism and electricity (not electric current). Yes, to me, Dr. Ehrenhaft's discovery has supplied the missing link, "magnetic current" being another manifestation of electron movement. In the meantime no one need forget the electron. It is here to stay, so much the better for humanity.

V. C. SKINNER,
Edmonton, Alta., Canada

WANTS INFORMATION ON THE COHERER

Dear Editor:

Your name has been given to me as one who can supply me with information about the early coherer method of radio telegraphy.

I would appreciate a description of construction and performance of this system. I would further appreciate any and all information which you can supply me.

Another question I should like to ask you is as follows: Is there any sensitive relay or simple microammeter which will respond to a simple crystal detector receiver circuit, if a relatively strong signal is used over a distance not over one mile?

DON MORAN,
Taft, California.

(We have at the present time no literature

on the early coherer method of radio telegraphy. Inasmuch as material of this type is completely obsolete, there is nothing in circulation now. You can get all this information from books at any of the large libraries if you go back to the years 1900 to 1915.

We know of no sensitive relay or microammeter which will respond to a simple crystal detector circuit unless the signal is extremely strong. If, for instance, you were near a 50,000-watt broadcasting station (within one mile) you could probably get a deflection on a microvoltmeter or microammeter. Whether this would be sufficiently strong to make a contact for relay purposes is not known. You will have to do some experimental work in connection with it.—Editor)

LICENSES FOR SERVICEMEN A JOKE?

Dear Editor:

There is some growth in the sentiment favoring the licensing of radio shops. Those who favor it assure us that it is to protect the "Dear peepul" from the harmful effects of the screw-driver mechanic. They ain't fooling anyone, not even themselves or the public, for we all know that it is an effort to force trade our way which we now have to be worthy of to get.

I wouldn't like it even if it would work because it is highly unsportsmanlike, to say the least.

And it won't work. If Paul Jones wants his neighbor kid Billy Smith to look at his radio because Billy was in the signal service or because Billy studied radio in school, there isn't a thing that we can do about it whether we have fancy laws or not. Neither is there any reason why we SHOULD be able to do anything about it. It is Jones' set and Jones' money, and things are getting pretty bad if I am authorized to order him to bring the set—and the money—to me because I have a paper and Billy hasn't.

If the trouble is something simple Billy will take care of it and a small job is lost to "us professionals," but if it is a job beyond the kindergarten stage Billy will either recommend that it be brought to us or he will do further damage in trying to fix it. Either way, we win.

The license would be a joke since it would depend more on one's knowledge of fifty-cent words than on one's ability (and willingness) to do a workmanlike job. Some of the "professionals" who would be licensed are right now turning out work that a screw-driver mechanic would—or at least should—blush at. They blame it on the war, of course, but that doesn't excuse some of the stuff I've seen.

Why not live and let live? Only the biggest liar among us would claim that we were well equipped and competent radio men when we serviced our first set. Under a free competitive system we will get as much of the business as we deserve. In more than twenty years of servicing and over fifty thousand repairs, I have seen some radio men go into other lines be-

cause their prices didn't give them a living and I have seen more of them quit because they thought they could get any price they asked or because they did sloppy work and their customers didn't agree to their prices or their work and walked out on them.

I just sorta jogged down the middle of the road and I still eat regular. I don't owe nobody nothin' and my income tax is painful enough so that I don't want it any bigger.

Convincing Paul Jones that he should bring his work to us will be a lot more effective than telling him that he has to do it.

The screw-driver mechanic has been with us, is with us and will be with us, but I fail to see why we should get all worked up over it.

CHARLES PILGRIM,
Aitkin, Minnesota

MAGNETIC MOTORS

(Continued from page 79)

apparatus used by the professor. Another backer was Brother Gabriel Kane, head of the Physics Department of Manhattan College. Mr. Reynolds' report is printed below:

STATEMENT OF CHARLES REYNOLDS AT THE ROCHESTER MEETING

Mr. Chairman and Gentlemen:

Led by curiosity as to the validity of the claims of Professor Ehrenhaft and his opposition concerning the evidence of the existence of a magnetic current and unit magnetic poles, which have been productive of so much controversy, I decided to attempt to repeat the experiments reported by both schools of thought.

So far as I have been able to determine, the only experiments in which the electromagnet was used were those of Kendall reported in *Nature* in February of this year.

There has been to date only one report printed concerning experiments with the permanent magnet. This was the work of Dr. Ehrenhaft appearing in the *Physical Review* in May.

Several experiments were carried out with the permanent magnet, in which rotational motions were observed in a liquid when the poles were both covered and uncovered. When insulated poles were used, slide cover glasses were used as covers.

In the experiments with the electromagnet, Kendall's work was repeated with two exceptions. First, I used a vertical field. Second, cadmium-plated poles were not available. However, when Kendall's work was done and his observational method was employed, his results were obtained in every case. When the same experiments were performed using Dr. Ehrenhaft's observational methods, Dr. Ehrenhaft's results were obtained.

In another series of experiments, rotational motions were observed in the following solutions: barium hydroxide, potassium chloride, sodium chloride, potassium hydroxide, sodium hydroxide, one-percent sulphuric acid, one-percent hydrochloric acid, copper sulphate, a copper suspension in copper sulphate, ferrous chloride, ferric chloride, cobalt nitrate, cobalt sulphate, nickel nitrate and a suspension of tungsten in distilled water. In many of these liquids, dual rotations against each other at the same time and in the same plane were observed. In others, this was not observed. Without exception, the direction of rotation was reversible with reversal of the field and the speed of rotation was a function of field strength. In some instances the poles were waxed.

Polar movements in a constant homogeneous vertical field in gases were observed. Manganese, tungsten, chromium, nickel, cobalt, iron, copper, aluminum, zinc, lead and brass were used. With some metals, such as tin, antimony and bismuth, no movement was observed. Where such a polar movement was obtained, all tracks were spirals or parts of spirals, many indicating a sudden change of electric as well as magnetic charge.

In another experiment, a suspension of manganese was prepared in a high-grade transformer oil. Spiral tracks of these particles were observed travelling with and against gravity. All of these particles moved at approximately the same speed and all terminated their movement on one or the other of the pole faces of the electro-magnet.

This report is not intended to be either a defense of Dr. Ehrenhaft as a personality or a personal attack on those who disagree with him. I am only trying to show that the results of Dr. Ehrenhaft's reports can be reproduced. If the field as a whole is not willing to accept his interpretation of these phenomena, it is clear that the phenomena exist and must be further investigated.

HARRISON HAS IT!

FOR URGENT
WAR WORK—

HALLICRAFTERS

RECEIVERS AND
TRANSMITTERS

TUBES
CONDENSERS
RESISTORS
TRANSFORMERS

AND THOUSANDS OF OTHER
CRITICAL ELECTRONIC PARTS!

PURCHASING AGENTS—

Call upon us for your high priority requirements of equipment and components for your production and development work.

We usually have it in stock!

FOR THE
HOME FRONT—

CODE PRACTICE SET

Buzzer and key, heavily nickel plated, of single unit construction, mounted on wood base. Adjustable high frequency pitch. Complete with silk covered cord, in attractive box with code chart on cover. Works on one or two flashlight or dry cells.

Postpaid—\$2.45

6L6G First grade, \$1.37 ea.
meter tested, 3 for \$3.75
TUBES fully guaranteed postpaid

DYKANOL CAPACITORS

Cornell-Dubilier oil filled, hermetically sealed metal cased condensers. 4 mfd. capacity. Rated at 220 Volts AC working, will stand over 600 Volts D.C. Ideal for amplifiers, receivers, power packs, etc. (Filtering action equivalent to 12 mfd. electrolytic but with better safety factor, longer life). \$2.25 (3 or more shipped postpaid).

P. M. DYNAMIC SPEAKERS

5 inch, with output transformer to match single plate of 8000 ohms \$1.95

(Not Postpaid)

Immediate delivery of the above items, without priority, while quantities last. Place L-265 or V-3 certification on your order. SEND REMITTANCE WITH ORDER, TODAY! (Money back if not satisfied.)

HARRISON

RADIO CORPORATION

11 WEST BROADWAY

Phone WOrth 2-6276

NEW YORK CITY 7

GET THIS HANDY CHEMICAL LABORATORY!

GENERAL CEMENT

RADIO CHEMICAL LABORATORY

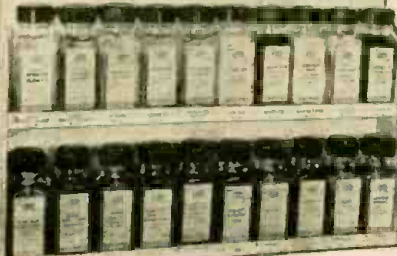

- Twenty 2 oz. Bottles
- Indexed Metal Rack
- Brushes in Bottle Caps

A Complete Assortment of Cements and Chemicals

The G-C Radio Chemical Laboratory contains a complete professional assortment of often needed cements, solvents, coil dopes, insulating varnishes, lubricants, contact cleaners, etc. The bottle you want is always instantly available from its place in the permanent indexed rack. Rack can be placed on bench or wall.

LIST PRICE \$8.17 WITH
FREE STEEL RACK

Order From Your
Radio Parts Jobber

GENERAL CEMENT MFG. CO.

ROCKFORD, ILLINOIS



TRAIN FOR
RADIO-ELECTRONICS IN 12 WEEKS
BY SHOP WORK
I'll Finance Your Training
Prepare for Jobs in Radio-Electronics,
by 12 weeks shop training in Cozy
Shops. Free Employment Service. Many earn
while learning. Whether or not you have had Radio
Electronics experience you need Cozy training. Write
for BIG FREE RADIO-ELECTRONICS BOOK, and my
"Pay-Tuition-After-Graduation" Plan.
C. Lewis, Pres., Radio-Electronics Div., Cozy Electrical
School, 500 S. Paulina St., Dept. 84-7H, Chicago 12, Illinois

• **Ted McElroy**
World's Largest Manufacturer of
Wireless Telegraphic Apparatus
COMPLETE CENTRAL OFFICE EQUIPMENT
McElroy Manufacturing Corp.
82 Brookline Avenue • Boston, Massachusetts

Working to CLOSEST TOLERANCE



● Aerovox silvered mica capacitors are designed for the most critical applications requiring precise capacitance values and extreme stability. Silver coating applied to mica and fired at elevated temperatures. Unit encased in molded XM low-loss red bakelite for silvered-mica identification.

SILVERED MICAS

Average positive temperature coefficient of only .003% per degree C.—a remarkably low value. Excellent retrace characteristics; practically no capacitance drift with time; exceptionally high Q. In three types: 1000 v. D.C. Test: Type 1469, .000005 to .0005 mfd.; Type 1479 (shown), .0001 to .001 mfd.; Type 1469, .00075 to .0025 mfd., and to .001 mfd. in 600 v. Standard tolerance plus/minus 5%. Also plus/minus 3, 2 and 1%.

● These and other capacitors are listed in the Aerovox catalog. Write on business letterhead for your copy. See our local jobber for your usual capacitor needs.

INDIVIDUALLY TESTED

AEROVOX CORP., NEW BEDFORD, MASS., U. S. A.
In Canada: AEROVOX CANADA LTD., HAMILTON, ONT.
Export: 13 E. 40 ST., NEW YORK 16, N. Y. Cable: 'ARLAB'

RADIO MONTH IN REVIEW

(Continued from page 77)

crystal and delivers precisely 100,000 pulses each second. The gate, actually a vacuum tube circuit, passes these pulses into the counter, which counts them and finally, when the gate is closed, shows by indicator lamps the number of pulses that have passed through. In other words it shows the number of hundred-thousandths of a second from the time the gate opened until it closed.

"This extraordinary speed and accuracy of operation," he continued, "is possible because there are no moving parts; the entire apparatus is electronic and can be started and stopped instantaneously."

In operation on the firing ranges, the counter's gate is opened by the electrical signal from the first coil as the bullet passes through it, and is closed again by the impulse from the second coil. The operator records the time of flight between coils and computes the velocity. It is noted down along with the record of the particular gun and projectile being tested for subsequent analysis by ballistic experts. The operator then touches the reset button and is ready for the next shot, all in a matter of a few seconds.

"The importance of such fine measurements become apparent," Engstrom explained, "when it is remembered that if all shells from a gun leave the muzzle with the same velocity, then they will all fall in the same spot, and the effectiveness of the fire will depend only on the skill and aim of the gunner. To insure this consistent performance, our arsenals are constantly measuring muzzle velocities of all types of guns and with all kinds of powder loads and shells."

COMING "SECRET" WEAPONS

(Continued from page 75)

to hold and entrap it. There are other considerations, too, such as the ultra-violet rays in the Solar spectrum. But ultra-violet rays also are a conductor of electricity, and if you have a sufficiently dense beam of ultra-violet radiation, you can make air conductive over a distance. Therefore, a powerful high tension current can be sent over an ultra-violet beam provided it has sufficient density. This is particularly true once you get out of the lower atmosphere and into the upper regions above the stratosphere. It is possible even today to equip planes with ultra-violet radiators which could hurl electrical destructive charges over such a beam and destroy other airplanes flying at equal height.

These are just a few considerations of many proposals, and many others will no doubt be evolved as time goes on. While the ones discussed are not on the "immediate" list, they should be taken seriously because they are all future weapons that will surely come about some day.

The Carnegie Institute of Washington announces that its new Cyclotron has been put into operation. Accelerating particles to an energy equivalent to a 15,000,000-volt field, the new machine has to be housed ten feet underground to prevent its radiations from reaching people outside. Indication of the effect of its rays was given by mice, who died within a few hours after being exposed to them for short periods.

USED Correspondence Courses
Complete HOME-STUDY Courses and self-instruction books, slightly used. Rent, sold, exchanged. All subjects. Satisfaction guaranteed. Cash paid for used courses. Full details & 92-page illustrated bargain catalog free. Write now. Dept. 2-39, Chicago 4, Ill.

Attention Radio Servicemen

Many hard to get items.
Send post card for new price list.

JOHN A. COX
WHOLESALE RADIO SUPPLIES
557-7th Street. Parkersburg, W. Va.

Index to advertisers

Aerovox	126
Allied Radio Corporation	114
Amplifier Co. of America	118
Audel & Company	107
Best Vibrator Co.	124
Bogen & Co. David	Inside front cover
Browning Laboratories, Inc.	74
Burgess Battery Co.	113
Burlingame Associates	106
Burstein-Applebee Co.	118
Cannon Co., C. F.	124
Cardwell Mfg. Co., Allen D.	120
Concord Radio Corporation	119
Coyne Electrical School	118, 124, 125
Cox, John A.	126
DeForest's Training	71
DeJur Amsco Co.	121
Echophone Radio Co.	105
Federal Telephone & Telegraph	121
General Cement Mfg. Co.	125
General Electric Co.	108
Halliercrafters Co., Inc.	67, 68
Harrison Radio Corp.	125
Henry Radio	109
Hudson Specialties	122
Insuline Corporation of America	115
Instruments Publishing Co.	116
Lancaster, Allwine & Rommel	124
McElroy	125
McGee Radio Co.	124
McGraw-Hill Book Co.	103
Meissner Mfg. Co.	70
National Radio Institute	65
National Schools	73
National Union Radio Corporation	72, 120
Nelson Company	126
Onan & Sons, D. W.	119
Opportunity Adlets	117

RADIO SCHOOL DIRECTORY

Page 128

Candler System	
Capitol Radio Engineering Institute	
Commercial Radio Institute	
Lincoln Engineering School	
N.Y. Y.M.C.A.	
Radio & Television Institute	
RCA Institutes	
Tri-State College	
Radio Corporation of America	97
Radio Electric Service Co.	115
Radio & Technical Division	
Murray Hill Book Co.	110, 111
Raytheon Mfg. Co.	Back cover
Sperry Gyroscope Co., Inc.	120
Sprague Products Co.	101
Sprayberry Academy of Radio	69
Supreme Instruments	104
Supreme Publications	117
Sylvania Electric Co.	99, 112
Triplet Instruments Co.	109
University Labs.	Inside back cover
Western Electric Co.	120
Wholesale Radio Laboratories	123

(While every precaution is taken to insure accuracy, we cannot guarantee against the possibility of an occasional change or omission in the preparation of this index.)

BOOK REVIEWS

TELEVISION, THE REVOLUTIONARY INDUSTRY, by Robert E. Lee, with a foreword by Dr. Lee de Forest. Published by Essential Books. Stiff cloth covers, 5 x 7½ inches, 230 pages. Price \$2.50.

The title, "Television, the Potentially Revolutionary Industry" might have been more appropriate to this book. The author shows how television could develop, freed from the mistakes and hindrances which hampered the evolution of radio broadcasting, yet shows no method nor gives any hope that it may escape the tribulations of its predecessor. On the contrary, he indicates several new "monkey-wrenches" which may be thrown into the gears of the coming industry.

The two chapters "The Moving Finger Writes" and "Enter the New Art" gives an excellent and simple non-technical description of television fundamentals and the details of staging a video show. Otherwise, the "bright" style of writing fails to harmonize with the serious nature of the subjects discussed.

Best part of the book is the forward by de Forest. The main arguments of the author are here summed up in language which lacks none of his picturesqueness, but contain a force not found in the text itself. Agreeing thoroughly with the author that handling of advertising is the critical point on which the life or death of Television may hang, he approves suggestions as to how legitimate advertising may be made actually entertaining, while warning, "For the cheap little advertiser with the cheap little mind, Television has only two words, 'Stay Out!'"

In spite of its several faults, this little book is worth reading by anyone who expects to be connected with the coming television industry. While the author's hopes as to its future may not all be fulfilled, his conclusions as to the facts and probabilities of the situation are all too correct, and his warnings may well be heeded, with profit to the industry and those connected with it.

DIRECT-CURRENT CIRCUITS, by Earle M. Morecock. Published by Harper & Brothers. Stiff cloth covers, 6½ x 9½ inches, 387 pages. Price \$3.75.

This is an elementary text book, designed for use in technical institutes, junior colleges and industrial or extension schools. No great knowledge of mathematics is required, simple algebra sufficing for any of the problems given.

The nature of electricity is the first topic discussed. Unfortunately, it is so handled that the innocent student might be led to believe in the two-fluid theory. Otherwise the material is well presented. Since the book is confined to direct current, it is possible to go into greater detail than in the usual beginner's text which has to divide its space between direct- and alternating-current circuits.

A great deal of actual apparatus used in power circuits is discussed and illustrated (often with excellent photographs). The chapter on magnetism, for example, describes magnetic separators, large lifting magnets, circuit breakers and automobile cutouts. Detailed drawings or photos make their operation clear to the student.

The latter chapters of the book constitute a second course at a slightly higher level,

again covering some of the subjects dealt with in the earlier chapters. Conductance and resistance, which is handled in the first chapter, comes up again in the seventh, where Kirchoff's Laws and the principle of superposition are explained.

Further chapters deal with the magnetic circuit, electromagnetic induction and electrostatics. The extensive treatment of these subjects should be helpful indeed to the student about to begin studying alternating currents.

A number of questions and problems are given at the end of each chapter, as an aid to class work or self-checking.

ALTERNATING CURRENTS FOR TECHNICAL STUDENTS, by Calvin C. Bishop. Published by D. Van Nostrand Co., Inc. Stiff cloth covers, 5½ x 8 inches, 424 pages. Price \$2.50.

The purpose of the author is to explain to technical and vocational students the fundamental principles of alternating-current theory, circuits and apparatus. The result is a book with very much simpler mathematics than most works on alternating-currents.

Theory and practice are well balanced. The principles underlying the generation of alternating currents are treated as well as such practical factors as field distortion due to load. Theoretical figures and photographs of actual apparatus appear close together in several sections of the book.

Vectors are very completely covered in two chapters, and the method of handling the subject is such that the student unfamiliar with them will find no difficulty in grasping what the author is trying to present. The method of building up certain vector diagrams often seen without explanation in other books, is dealt with at length.

Some of the more practical matter is less well handled. It would be difficult for a student with no previous knowledge of three-phase to understand some of the material of Chapter 2, especially the directions for connecting the coils, and the drawings which illustrate them.

Static A.C. circuits are simply handled and the discussion on parallel circuits will be appreciated by beginning students. Other subjects outside the alternator-transformer-motor group which naturally occupies the greater part of the book are electron tubes and circuits; meters, arrestors, reactors and relays; power measurements; and practical tests and checks.

FIELDS AND WAVES IN MODERN RADIO, by Simon Ramo and John R. Whinnery. Published by John Wiley and Sons. Stiff cloth covers, 5½ x 8½ inches, 502 pages. Price \$5.00.

First prepared as material for General Electric Company courses in which the students were at the same time starting their career as engineers, this book blends physical and mathematical presentation of its subject in an interesting manner, which should make it not only valuable as a text but useful as supplementary reading to students working with other books.

The important objects of the book, as stated by the authors in the preface, were to treat high-frequency circuits, skin effect, shielding problems, wave transmission and reflection, transmission lines and wave guides, cavity resonators and high-frequency radiating systems.

In pursuit of the above objective, the book opens with chapters on oscillation and wave fundamentals, equations of stationary electric and magnetic fields, solutions to static field problems, Maxwell's equations, high-frequency potential concepts, circuit concepts and their validity at high frequencies.

These are followed by chapters on skin effect and circuit impedance elements; propagation and reflection of electromagnetic waves; guided waves; transmission characteristics on common wave guides and transmission lines and resonant cavities.

The manner in which the treatment of waves in transmission lines is merged into that of propagation through wave guides is worthy of notice. So also is the treatment of resonant cavities, both of these illustrating well the attention paid to physical understanding of the phenomena under study.

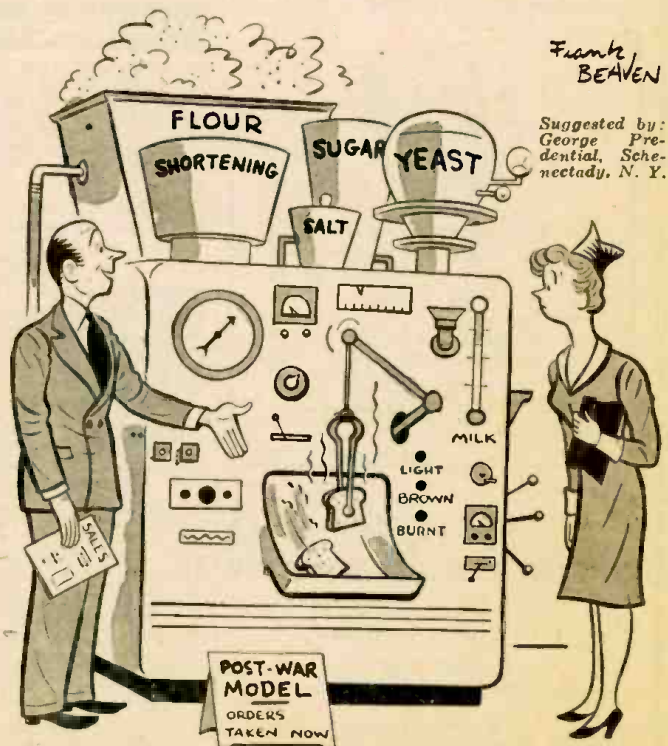

"And you turn the dial to the right, press this middle valve down, and out comes a slice of toast."

... Here's how YOU Can Qualify for a BETTER RADIO JOB!

... CREI technical training is preparing others for good-paying radio jobs—WHY NOT YOU?

Are you finding yourself in a routine job—a job that any other man can handle just as well as you? Today, radio JOBS are many—but radio CAREERS are few! Now is the opportune time for you to equip yourself with the necessary technical training to qualify for an important engineering position with a sound future.

NOW when industry needs men, is the time for you to investigate radio career training. Your radio experience backed by modern CREI technical training will equip you to share in the good-paying jobs that await trained men . . . and to make good in the important positions that lead to security and happiness!



WRITE TODAY! If you are a professional or amateur radioman and want to make more money—let us prove to you we have something you need to qualify for the better job opportunities that can be yours. To help us intelligently answer your inquiry — please state briefly your education, radio experience and present position.

CAPITOL RADIO ENGINEERING INSTITUTE

Home Study Courses in Practical Radio-Electronics Engineering for Professional Self-Improvement

Dept. RC-11, 3224 16th Street, N. W.
WASHINGTON 10, D. C.

Contractors to U.S. Navy—U.S. Coast Guard—Canadian Broadcasting Corp.—Producers of Well-trained Technical Radiomen for Industry

RADIO SCHOOL DIRECTORY

PREPARE NOW FOR POST-WAR RADIO AND ELECTRONICS

MAKE a place for yourself in a new world of radio and electronics—a world in which revolutionary electronic developments will require highly specialized technical knowledge. Take a good course now to fit yourself for a good paying job. The training you need can be supplied by one of the schools advertised in this publication.

RADIO-TELEVISION ELECTRONICS

offer ever-increasing post-war opportunities for trained men and women. R-T 1 courses prepare you by combining theory with practical laboratory experience.

Consideration given to Veterans eligible for training under the G. I. Bill.
Day & Evening Sessions. Apply daily 9-9, Sat. 9-2. Request Information.

Radio-Television Institute

480 Lexington Avenue, N. Y. 17 (46th St.)
Plaza 3-4585 Licensed by N. Y. State

COMMERCIAL RADIO INSTITUTE

A radio training center for
twenty-four years.

ACCREDITED FOR VETERAN TRAINING
RESIDENT COURSES ONLY

Pre-Induction, Broadcast, Service, Aeronautical, Television and Marine telegraphy classes now forming for fall term Oct. 9. Literature upon request.

Home Study Course in Mathematics

Dept. C., 38 West Biddle St., Baltimore 1, Md.

RADIO TECHNOLOGY



RCA Institute offers an intensive two-year course of high standard embracing all phases of Radio and Television. Practical training with modern equipment. Also shorter specialized courses in Commercial Radio Operating, Radio and Television Servicing, and Aviation Communications. For Free Catalog write Dept. RC-44.

RCA INSTITUTES, Inc.

A Radio Corporation of America Service
75 VARICK STREET NEW YORK 13, N. Y.

RADIO ENGINEERING I

EX-SERVICE MEN can complete work here in shortest possible time. Special Prep. Dept. Also REFRESHER COURSES. Courses also in Civil, Electrical, Mechanical, Chemical, Aeronautical Engineering; Business Administration. Accounting, Secretarial Science. Tuition, living costs low. 61st year. Cosmopolitan student body. Enter Jan., Mar., June, Sept. Catalog.

TRI-STATE COLLEGE 24114 College Ave.
ANGOLA, INDIANA

CODE SENDING RECEIVING SPEED

Be a "key" man. Learn how to send and receive messages in code by telegraph and radio. Army, Navy and Commerce need thousands of men. Good pay, adventure, interesting work. Learn at home quickly through famous Candler System. Write for FREE BOOK.

CANDLER SYSTEM CO.
Dept. 3-M, Box 928, Denver 1, Colo., U.S.A.

Pre-Induction RADIO COURSES

for Civilians and those entering Military Services. New classes now starting for men and women.

• RADIO OPERATING • CODE
• RADIO SERVICING • ELECTRONICS
New York Y.M.C.A. Schools
4 W. 64th Street New York City

Electron microscopes of the future may achieve useful magnification as high as 200,000 diameters, according to R.C.A.'s Dr. Zworykin and Dr. Hillier.—*Allied News*

Correspondence Courses in RADIO and ELECTRICAL ENGINEERING

ELECTRICAL ENGINEERING Get good grasp of wide electrical field. Prepare yourself, at Low Cost, for secure future. Modern, simplified, you can understand quickly.
RADIO ENGINEERING Extra fine course in radio, public address, photo-electric work. Trains you to be super-service man, real vacuum tube technician. Servicemen needed badly. Diploma on completion. Tuition \$25, either course. Deferred payment plan.
FREE Get copies of school catalogs, student magazines, complete details. SEND NOW!
LINCOLN ENGINEERING SCHOOL Box 61-C69
Lincoln, Nebr.

SURRENDER SPEAKER

(Continued from page 80)

and is an important forward step in psychological warfare. The system can be used with reasonable safety, because the operators are at a goodly distance from the enemy where they are not overly endangered by his fire—unless it be artillery fire. It is also possible to set up the loud-speaker in such a manner that it can be reasonably sheltered by hiding it in buildings, behind trees or bushes, within a forest, or otherwise, where the enemy cannot actually see it. It can be operated in torrential rains, as well as in the densest fogs, although during such conditions the range is cut.

These modern sound means have been of particular value when the enemy has been encircled or contained in a pocket. In such cases, the sound personnel approaches as close to the front as is feasible, and the operator, who must speak fluently in his opponent's language, then addresses the message to the enemy. He is told that the situation is hopeless, that further bloodshed is useless, and full directions are given to him for surrender.

Particularly at Cherbourg and other Normandy areas, these arguments brought about surrender of many hundreds of German soldiers, according to the *New York Times*. The future will see many more.

The apparatus is composed of two amplifiers, a multi-unit horn-type speaker, a speaker mounting stand, two lip microphones and two power units, with necessary interconnecting cables and switches.

Each amplifier, when used on a 115-volt supply, has a rated output of 175 watts. The peak output may reach 350 watts. Rating is for voice frequencies between 800 and 5,000 cycles.

Several special features which would be out of place in high-fidelity public address equipment feature this system. The 800-5,000-cycle frequency range is one of these. Another is the compressor system, which maintains a more or less constant level of output as the speaker's voice increases or decreases in volume. The frequency response is also designed to have a rising characteristic, to overcome high level noise which often prevails under combat conditions.

"Keep the Prices Down!" is a word of friendly advice to television manufacturers in a recent survey. An example drawn from the experience of refrigerator manufacturers shows that in 1926, when the average price of an electric refrigerator was \$390, sales totalled 210,000. In 1941, with average price \$150, total sales were 3,700,000.

MAKING THE

HEADLINES

IN TIME OF WAR

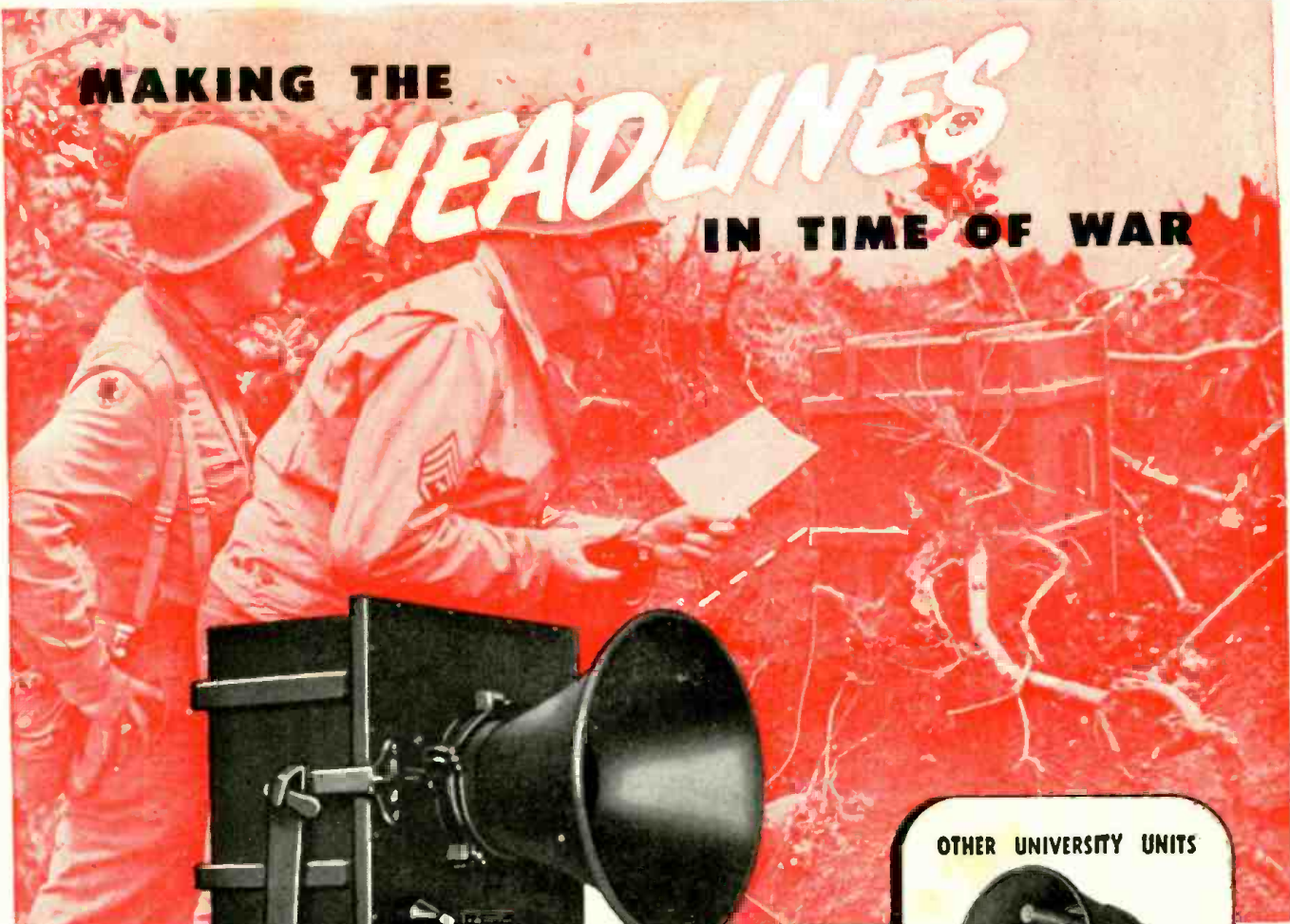

ACME PHOTO

..and tooling-up for peacetime needs!

UNIVERSITY SUPER POWER SPEAKERS

Carrying psychological warfare several miles to enemy strongholds, is news indeed. On many fronts, words—threatening, convincing, educating—vie with steel in cracking morale . . . undermining resistance . . . and effecting surrender.

That's the news in the headlines today—made possible, in part, by UNIVERSITY Sound Projectors, such as the B12 speaker (used with the Signal Corps MC 225 Sound System), shown in the actual combat photo above. And that is but one phase of the score of tactical and strategic functions of UNIVERSITY equipment now utilized throughout the world.

On beachheads, ship-to-ship, between

mobile vehicles, etc. — or wherever radio or signal light communication might establish a definite, dangerous 'fix' for enemy rangefinders—this quality line of sound projectors is serving . . . dependably and efficiently. Perfect reproduction and clarity are attained at full power, in every climate and terrain, with coverage up to TWO miles.

But the big news is behind the headlines—the diversity of proved speakers and projectors which will be available for every post-war application. In the meantime, we are still supplying our standard line of industrial and outdoor loudspeakers, etc.

Literature and technical details will be sent on request; write today.

OTHER UNIVERSITY UNITS



MODEL AA7C MULTI-REFLEX PROJECTOR

Mounts a battery of 7 PAH drivers. Capacity 250 watts. Frequency range 250 to 5000 cycles, projection up to two miles. Compact, rugged, hermetically sealed drivers are immune to severest exposure.



MODEL B12C MULTI-DRIVER PROJECTOR

Incorporates 12 special driver units with combined capacity of 400 watts. Frequency range 300 to 5000 cycles. Absolutely free of rattle, mechanical or acoustical resonance. This unit converts with unusual clarity and efficiency.



LABORATORIES, 225 VARICK ST., NEW YORK 4, N. Y.

THE ELECTRONIC AUTOMATIC PILOT
BRINGS THEM THROUGH

WITH **RAYTHEON**
TUBES

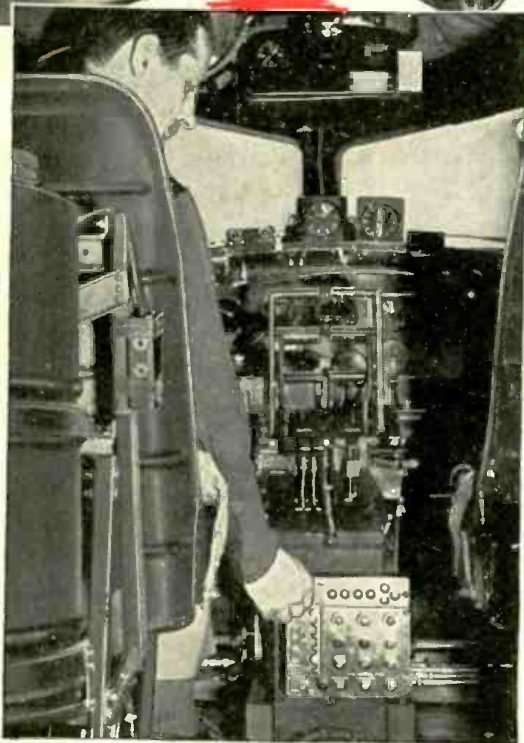
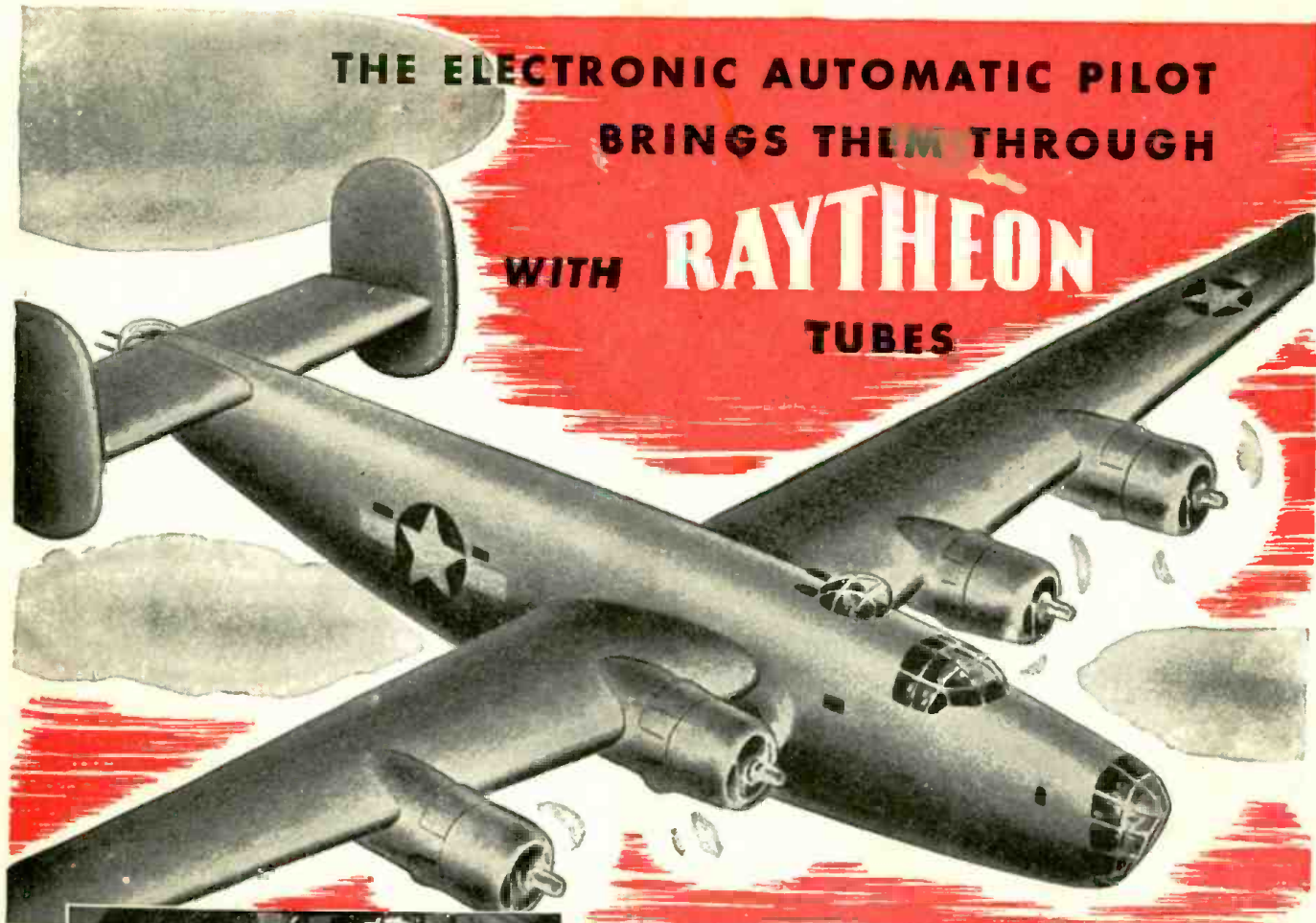

THE ELECTRONIC AUTOMATIC PILOT, pioneered and developed by Minneapolis-Honeywell, is one of the most significant advances made in aircraft science. Developed to keep bombers on a straight course in their bombing run, the electronic automatic pilot promises safer and more efficient flight for airlines . . . and, because this device must operate with complete reliability at all times, Minneapolis-Honeywell uses thousands of RAYTHEON tubes.

The special wartime experiences of Raytheon Manufacturing Company in devising and producing advanced electronic tubes for the war effort, means that you will be able to offer your customers the best tubes for all applications. Because you have the best tubes, you will have better customer good-will, faster turnover and greater profits.

Raytheon Manufacturing Company

RADIO RECEIVING TUBE DIVISION

Newton, Massachusetts • Los Angeles • New York • Chicago • Atlanta



All Four Raytheon Divisions Have Been
Awarded Army-Navy "E" Plus Stars

RAYTHEON
High Fidelity

RADIO AND ELECTRONIC TUBES



DEVOTED TO RESEARCH AND MANUFACTURE OF TUBES FOR THE NEW ERA OF ELECTRONICS